

1998 KE100 PARTS DIAGRAM

Crankcase

E1411

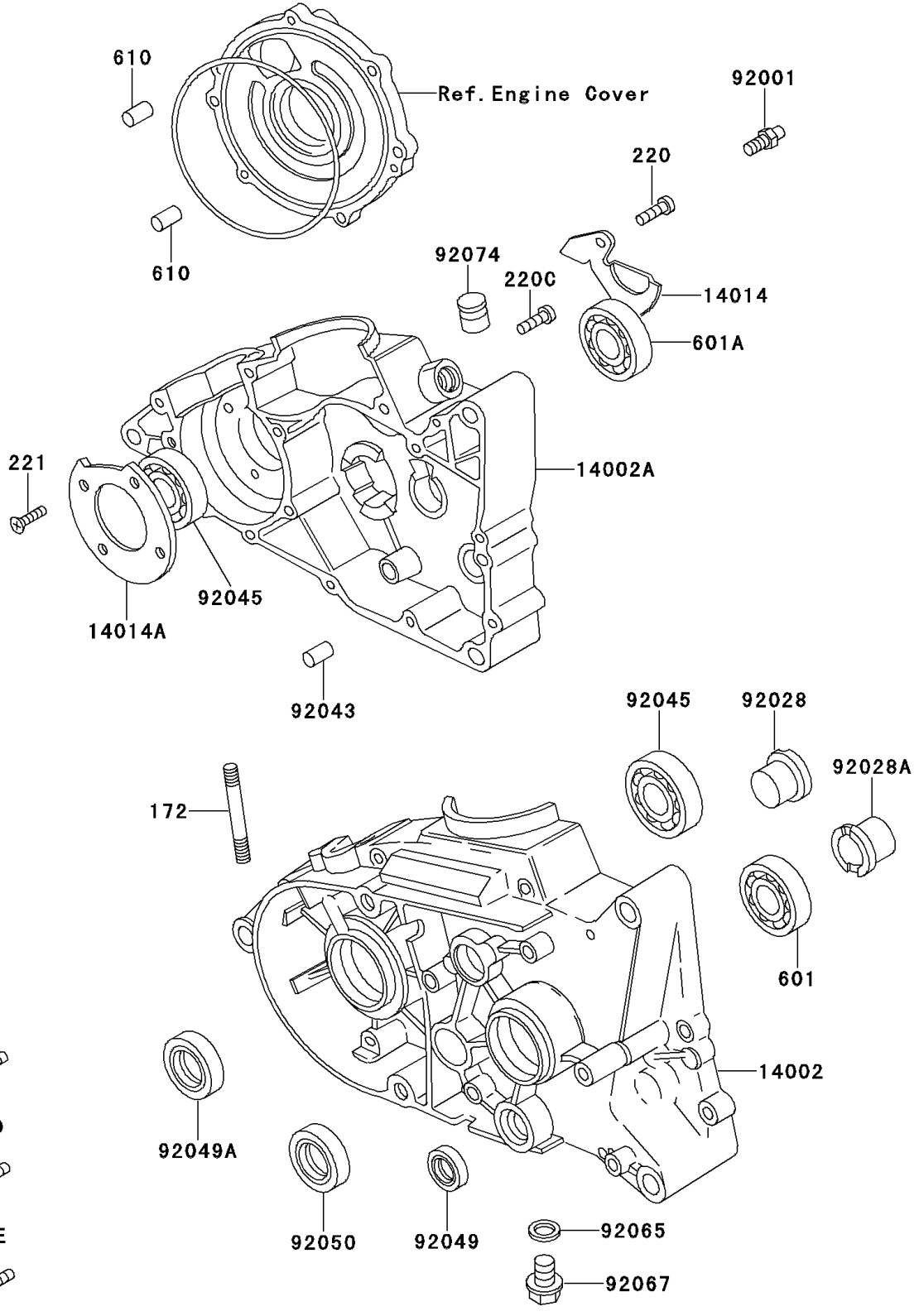

1998 KE100 PARTS LIST

Crankcase

ITEM NAME	PART NUMBER	QUANTITY
BOLT-STUD,8X115 (Ref # 172)	172G08115	4
SCREW-PAN-CROS,6X12 (Ref # 220)	220B0612	1
SCREW-PAN-CROS,6X25 (Ref # 220A)	220B0625	2
SCREW-PAN-CROS,6X40 (Ref # 220B)	220B0640	5
SCREW-PAN-CROS (Ref # 220C)	220X0620	1
SCREW-PAN-CROS (Ref # 220D)	220X0660	3
SCREW-PAN-CROS (Ref # 220E)	220X0665	3
SCREW-CSK-CROS,6X16 (Ref # 221)	221B0616	4
BEARING-BALL,#6004C3 (Ref # 601)	601B6004	1
BEARING-BALL,#6005C3 (Ref # 601A)	601B6005	1
ROLLER,5X12 (Ref # 610)	610A0512	2
CRANKCASE,LH (Ref # 14002)	14002-1074	1
CRANKCASE,RH (Ref # 14002A)	14002-1210	1
PLATE-POSITION (Ref # 14014)	14014-008	1
PLATE-POSITION (Ref # 14014A)	14014-017	1
BOLT,CHANGE DRUM STOP (Ref # 92001)	92001-1426	1
BUSHING,L=23.5 (Ref # 92028)	92028-025	1
BUSHING,L=14 (Ref # 92028A)	92028-069	1
PIN,8X16 (Ref # 92043)	92043-1322	3
BEARING-BALL,#6204 (Ref # 92045)	92045-1032	2
SEAL-OIL,SB12205 (Ref # 92049)	92049-004	1
SEAL-OIL (Ref # 92049A)	92049-1481	1
SEAL-OIL,SC25376 (Ref # 92050)	92050-013	1
GASKET,10.5X16X1 (Ref # 92065)	92065-058	1
PLUG,DRAIN,10X12 (Ref # 92067)	92067-001	1
PLUG,15X19 (Ref # 92074)	92074-035	1