

1993 KE100 PARTS DIAGRAM

Brake Pedal

F2260

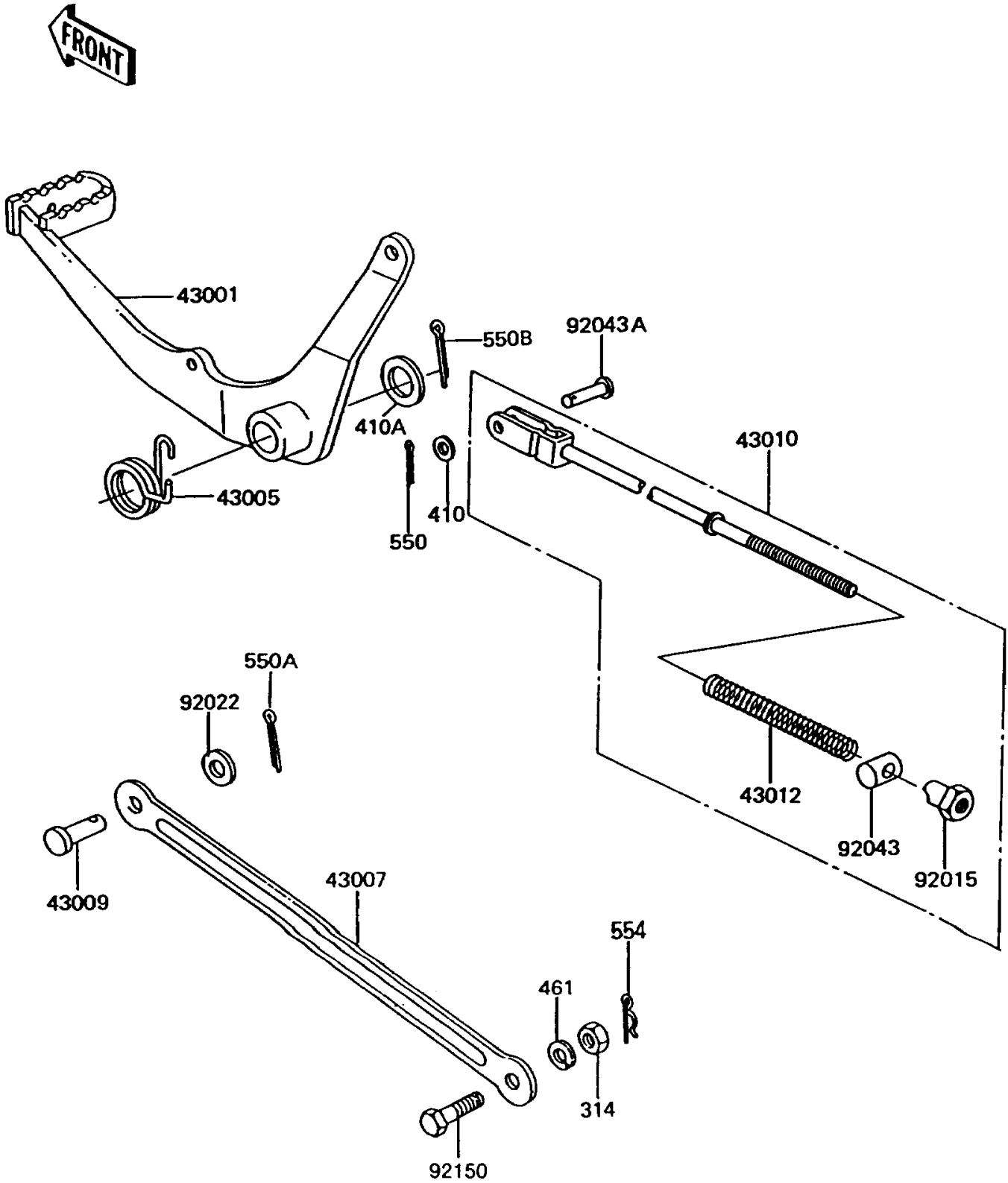

1993 KE100 PARTS LIST

Brake Pedal

ITEM NAME	PART NUMBER	QUANTITY
NUT-HEX-FINE,10MM (Ref # 314)	314B1000	1
WASHER-PLAIN-SMALL,6MM (Ref # 410)	410B0600	1
WASHER-PLAIN-SMALL,14MM,BLACK (Ref # 410A)	410F1400	1
WASHER-SPRING,10MM (Ref # 461)	461F1000	1
PIN-COTTER,2.0X15 (Ref # 550)	550D2015	1
PIN-COTTER,2.5X15 (Ref # 550A)	550D2515	1
PIN-COTTER,3.0X30 (Ref # 550B)	550D3030	1
PIN-SNAP,8MM (Ref # 554)	554A0800	1
LEVER-BRAKE,PEDAL (Ref # 43001)	43001-056	1
SPRING,BRAKE PEDAL (Ref # 43005)	43005-007	1
ROD-TORQUE,RR (Ref # 43007)	43007-028	1
PIN,SPRING,10X12 (Ref # 43009)	43009-001	1
ROD-ASSY-BRAKE (Ref # 43010)	43010-5001	1
SPRING,BRAKE ROD (Ref # 43012)	43012-001	1
NUT,BRAKE ROD (Ref # 92015)	92015-042	1
WASHER,10.5X18X1.6 (Ref # 92022)	92022-1539	1
PIN,BRAKE ROD (Ref # 92043)	92043-039	1
PIN,6X17 (Ref # 92043A)	92043-064	1
BOLT,10X32 (Ref # 92150)	92150-1872	1