

## 1995 KE100 PARTS DIAGRAM

Swingarm/Shock Absorber

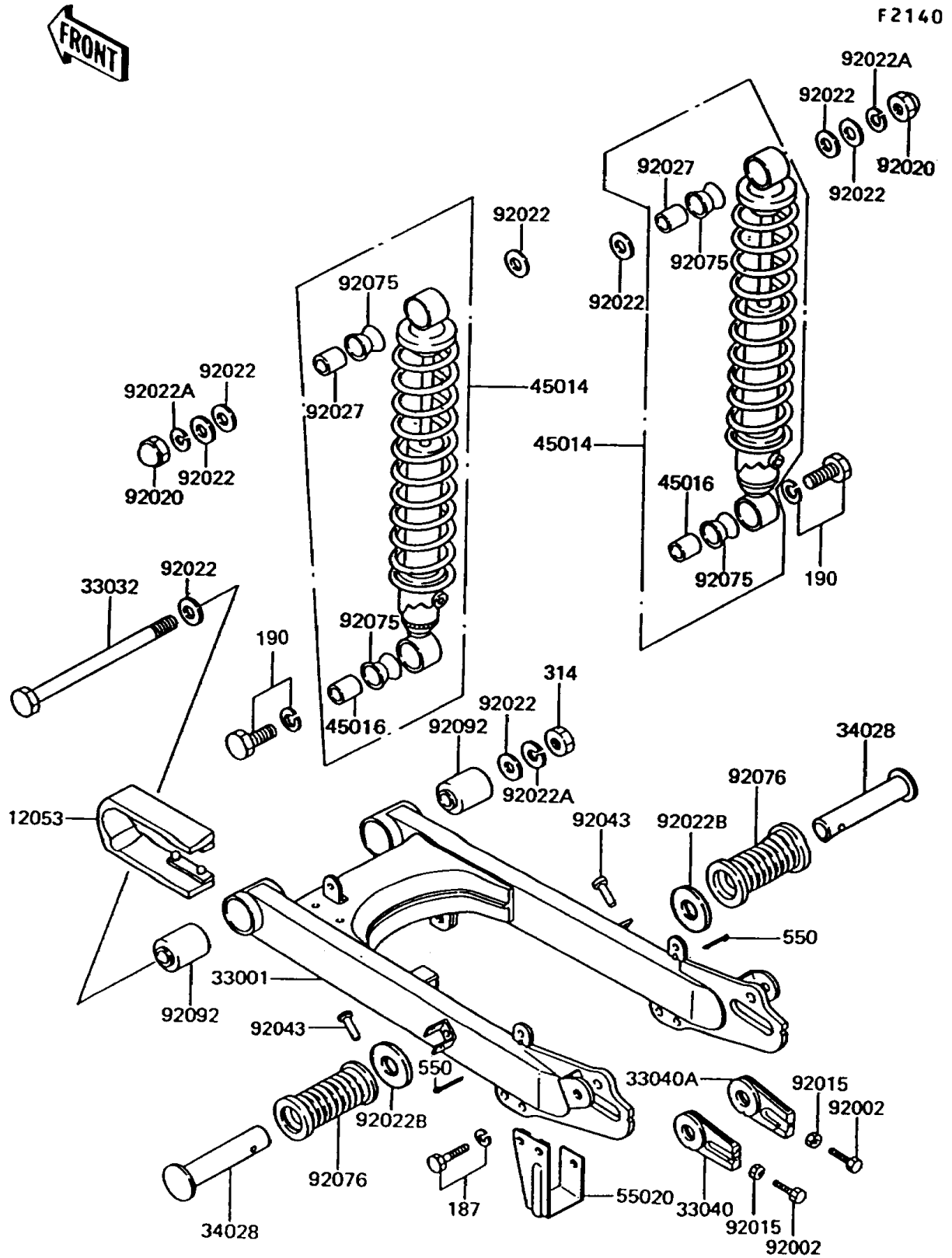

## 1995 KE100 PARTS LIST

Swingarm/Shock Absorber

ITEM NAME	PART NUMBER	QUANTITY
BOLT-UPSET-WSP (Ref # 187)	187X0616	1
BOLT-UPSET-WS (Ref # 190)	190N1035	1
NUT-HEX-FINE (Ref # 314)	314B1200	1
PIN-COTTER,2.0X15 (Ref # 550)	550D2015	1
GUIDE-CHAIN,NYLON (Ref # 12053)	12053-1066	1
ARM-COMP-SWING,SILVER (Ref # 33001)	33001-1118	1
SHAFT-SWING ARM (Ref # 33032)	33032-034	1
ADJUSTER-CHAIN,LH (Ref # 33040)	33040-045	1
ADJUSTER-CHAIN,RH (Ref # 33040A)	33040-046	1
STEP,RR (Ref # 34028)	34028-009	1
SHOCKABSORBER (Ref # 45014)	45014-1144	1
COLLAR,SHOCKABSORBER (Ref # 45016)	45016-003	1
GUARD,CHAIN (Ref # 55020)	55020-012	1
BOLT,CHAIN ADJUSTER,8X50 (Ref # 92002)	92002-1076	1
NUT,8MM (Ref # 92015)	92015-1364	1
NUT,CAP,12MM (Ref # 92020)	92020-014	1
WASHER,12MM (Ref # 92022)	92022-1538	1
WASHER,SPRING,12MM (Ref # 92022A)	92022-1541	1
WASHER,20X30X2.3 (Ref # 92022B)	92022-1568	1
COLLAR,SHOCKABSORBER (Ref # 92027)	92027-1063	1
PIN,6X28 (Ref # 92043)	92043-1464	1
DAMPER,SHOCKABSORBER (Ref # 92075)	92075-1020	1
DAMPER (Ref # 92076)	92076-020	1
BUSHING-RUBBER (Ref # 92092)	92092-005	1