

1993 KE100 PARTS DIAGRAM

Clutch

E1350

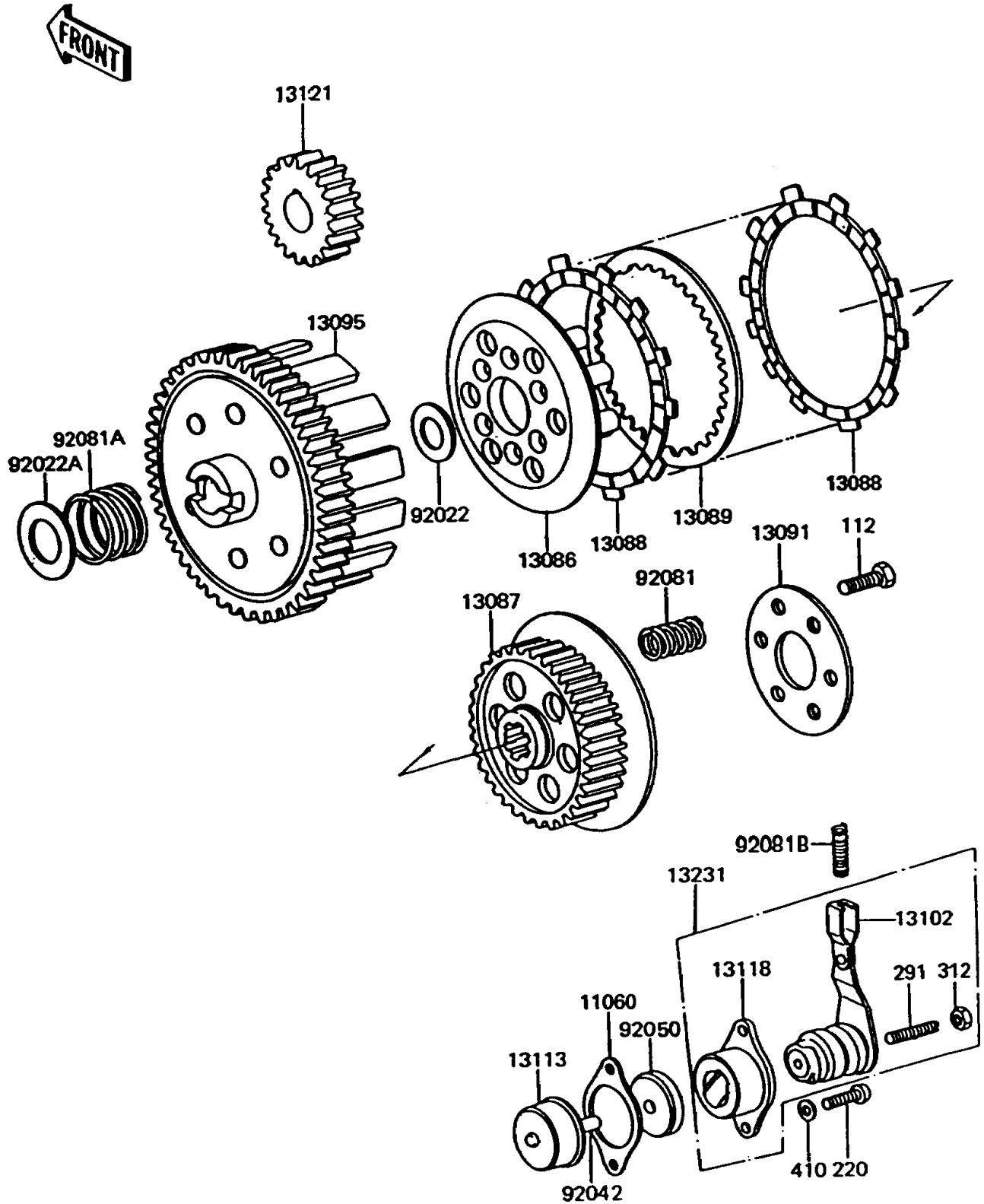

1993 KE100 PARTS LIST

Clutch

ITEM NAME	PART NUMBER	QUANTITY
BOLT-UPSET (Ref # 112)	112G0516	6
SCREW-PAN-CROS,6X16 (Ref # 220)	220B0616	2
SCREW-SET,6X16 (Ref # 291)	291H0616	1
NUT-HEX,6MM (Ref # 312)	312B0600	1
WASHER-PLAIN-SMALL,6MM (Ref # 410)	410B0600	2
GASKET,CLUTCH RELEASE (Ref # 11060)	11060-1197	1
WHEEL-CLUTCH (Ref # 13086)	13086-1002	1
HUB-CLUTCH (Ref # 13087)	13087-1011	1
PLATE-FRICTION (Ref # 13088)	13088-1010	4
PLATE-CLUTCH,STEEL (Ref # 13089)	13089-1009	3
HOLDER,CLUTCH SPRING (Ref # 13091)	13091-1115	1
HOUSING-COMP-CLUTCH (Ref # 13095)	13095-1277	1
RELEASE-COMP-CLUTCH,INNER (Ref # 13102)	13102-1016	1
PUSHER-COMP-CLUTCH (Ref # 13113)	13113-003	1
RELEASE-CLUTCH OUTER (Ref # 13118)	13118-1001	1
GEAR-PRIMARY SPUR (Ref # 13121)	13121-036	1
RELEASE-ASSY-CLUTCH (Ref # 13231)	13231-1008	1
WASHER,16.5X27X1.4 (Ref # 92022)	92022-054	1
WASHER,25.5X36X1 (Ref # 92022A)	92022-057	1
PIN,DOWEL,7X20 (Ref # 92042)	92042-043	1
SEAL-OIL (Ref # 92050)	92050-071	1
SPRING,CLUTCH (Ref # 92081)	92081-012	6
SPRING,CLUTCH DAMPER (Ref # 92081A)	92081-015	1
SPRING,CLUTCH RELEASE (Ref # 92081B)	92081-096	1