

## 1989 KE100 PARTS DIAGRAM

Fuel Tank

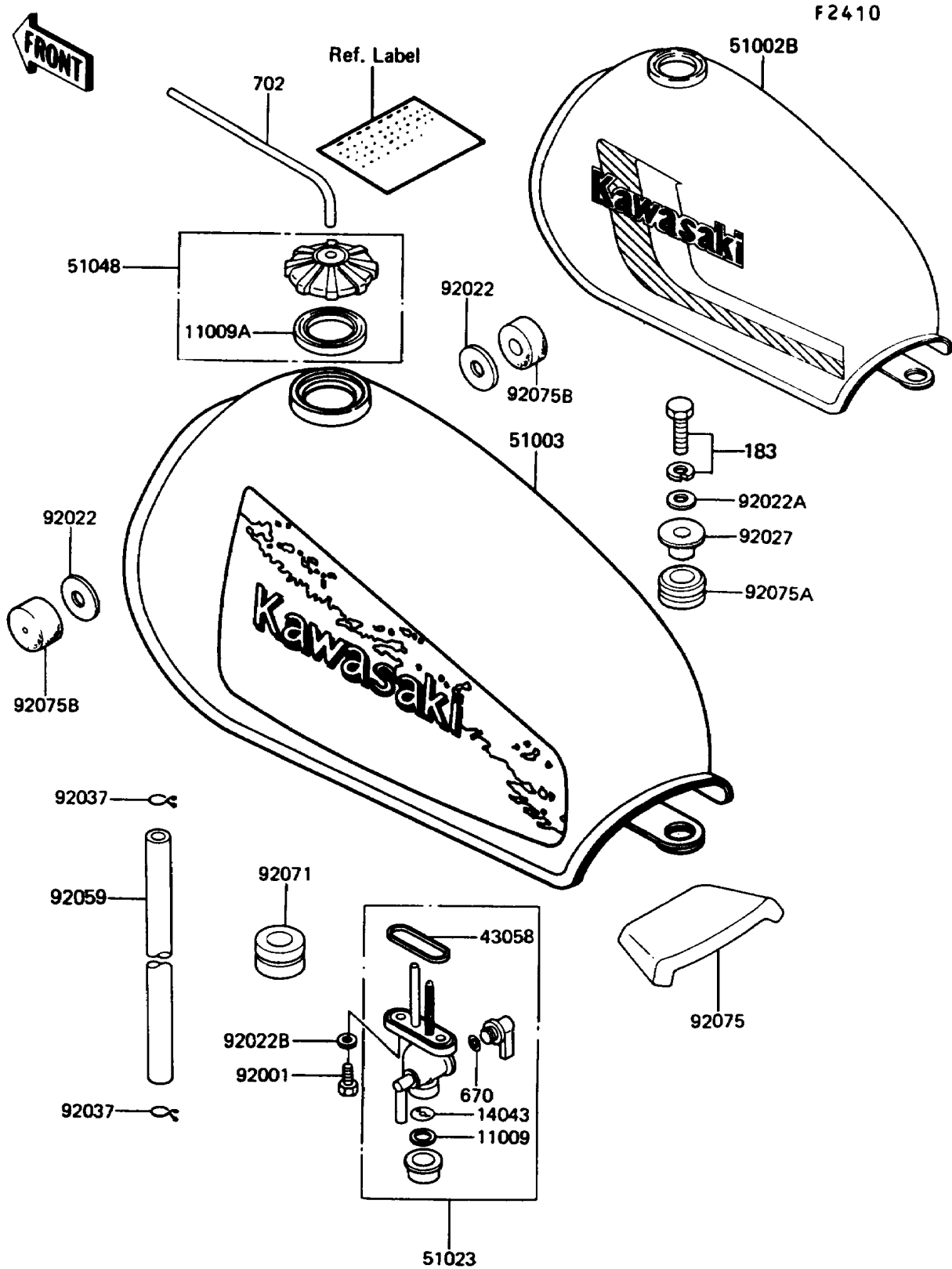

## 1989 KE100 PARTS LIST

Fuel Tank

ITEM NAME	PART NUMBER	QUANTITY
GASKET,FUEL TAP CUP (Ref # 11009)	11009-1013	1
GASKET,FUEL TANK CAP (Ref # 11009A)	51059-006	1
FILTER,FUEL TAP (Ref # 14043)	14043-1002	1
RING,TAP FLANGED (Ref # 43058)	51039-003	1
TANK-COMP-FUEL,P.WHITE (Ref # 51002B)	51002-5250-F1	1
TAP-ASSY,FUEL (Ref # 51023)	51023-1020	1
CAP-ASSY-TANK,FUEL (Ref # 51048)	51048-1004	1
BOLT,6X20 (Ref # 92001)	92001-1091	1
WASHER,10.5X26X2.3 (Ref # 92022)	92022-044	1
WASHER,8.5X26X1.6 (Ref # 92022A)	92022-092	1
WASHER,6.2X11X1.5 (Ref # 92022B)	92022-183	1
COLLAR,12.7X15.9X19 (Ref # 92027)	92027-223	1
CLAMP,TUBE (Ref # 92037)	92037-010	1
TUBE,4.5X9X290 (Ref # 92059)	92059-132	1
GROMMET,PIPE (Ref # 92071)	92071-038	1
DAMPER,FUEL TANK (Ref # 92075)	92075-106	1
DAMPER (Ref # 92075A)	92075-1086	1
DAMPER,FUEL TANK (Ref # 92075B)	92075-125	1
BOLT-UPSET-WS-SMALL (Ref # 183)	183B0835	1
O RING,10MM (Ref # 670)	670B2010	1
TUBE-RUBBER,5X300 (Ref # 702)	702A05300	1