

1991 KE100 PARTS DIAGRAM

Step

F2160

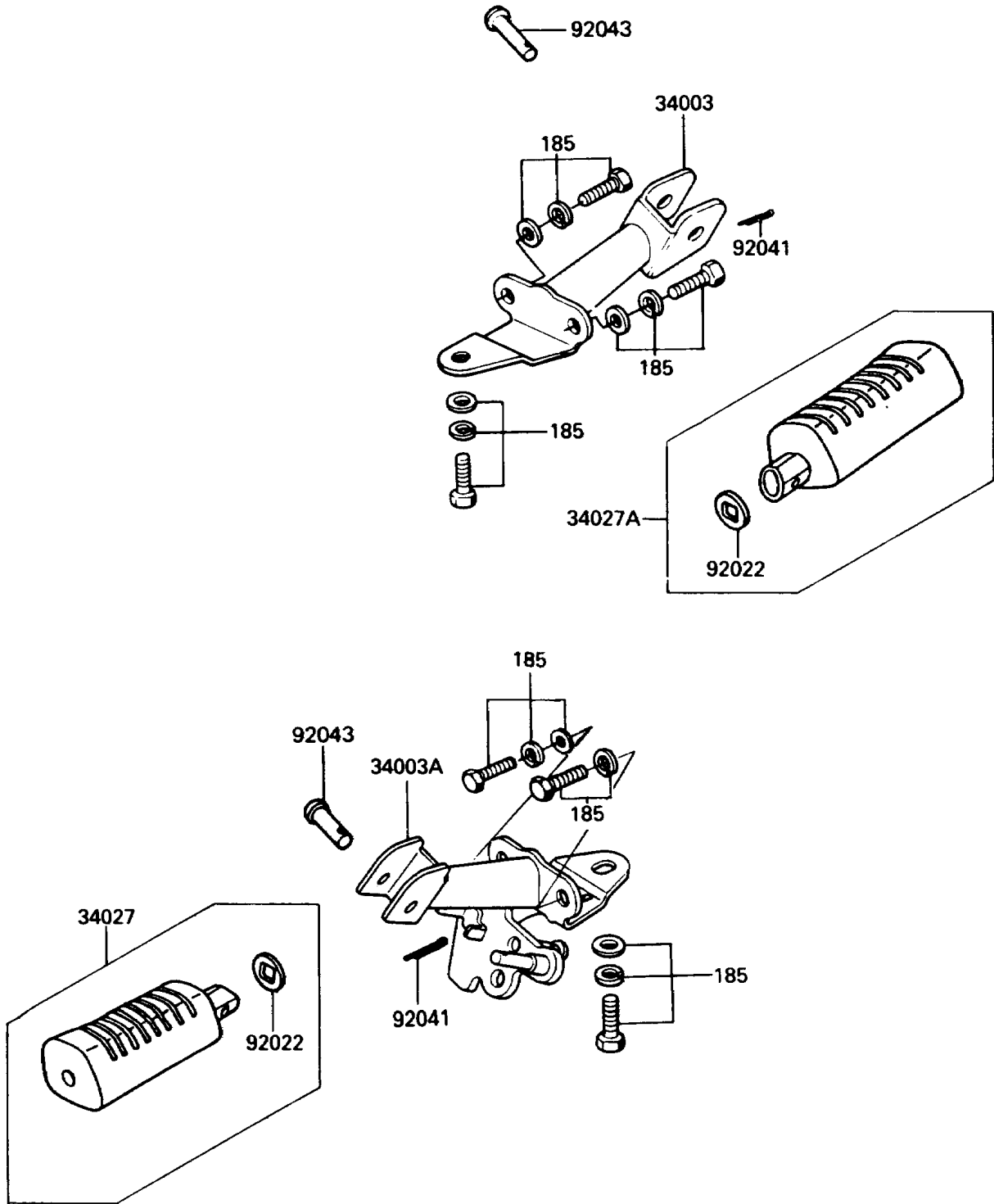

1991 KE100 PARTS LIST

Step

ITEM NAME	PART NUMBER	QUANTITY
HOLDER-STEP,RH (Ref # 34003)	34003-050	1
HOLDER-STEP,LH (Ref # 34003A)	34003-1073	1
STEP-ASSY,FR,LH (Ref # 34027)	34027-1114	1
STEP-ASSY,FR,RH (Ref # 34027A)	34027-1115	1
WASHER,STEP FITTING (Ref # 92022)	92022-1314	2
COTTER,2.5X15 (Ref # 92041)	92041-1051	2
PIN,8X31 (Ref # 92043)	92043-080	2
BOLT-UPSET-WSP-SMALL (Ref # 185)	185J0818	6