

1989 KE100 PARTS DIAGRAM

Frame

F2120-0073

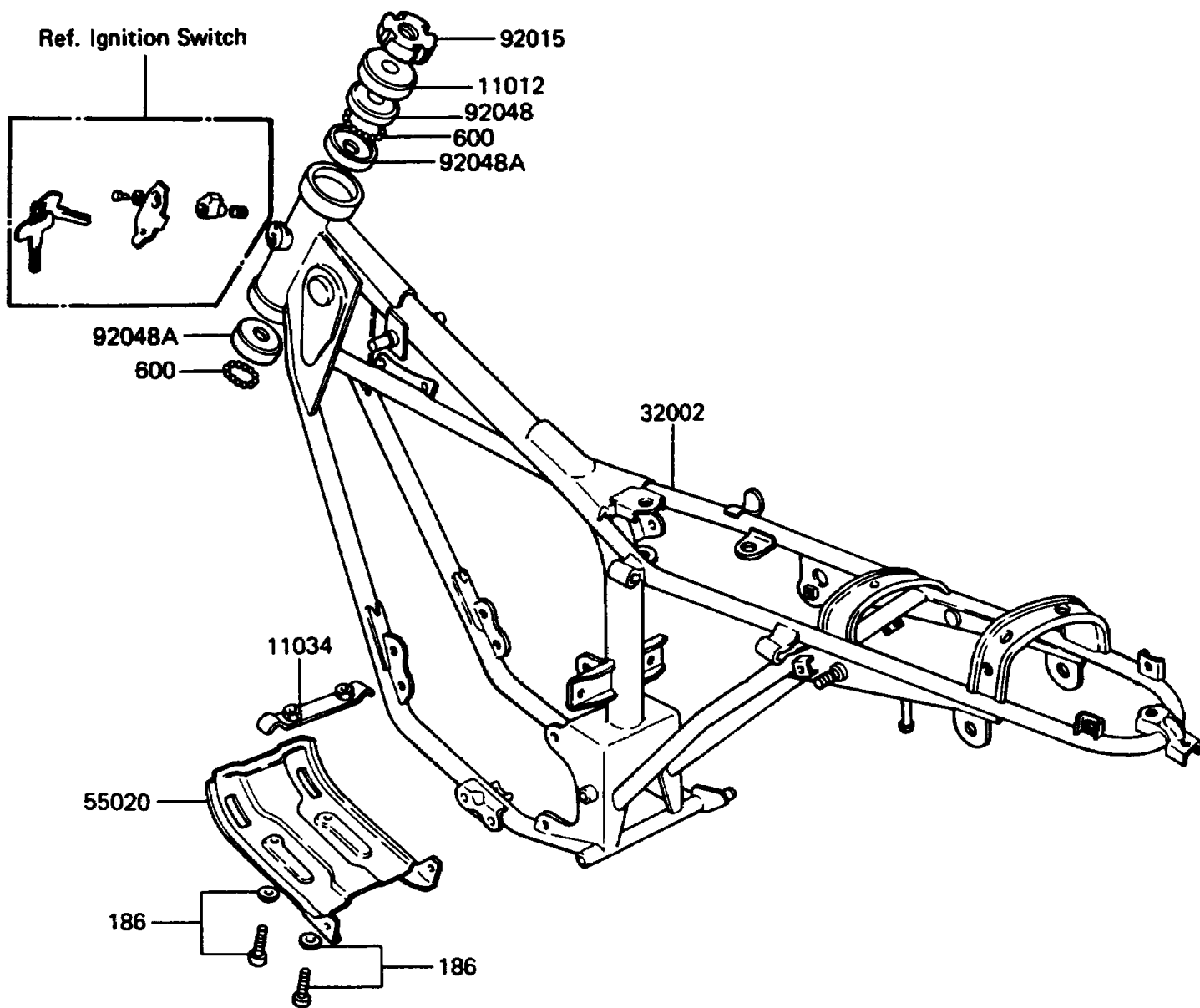

1989 KE100 PARTS LIST

Frame

ITEM NAME	PART NUMBER	QUANTITY
CAP,STEERING STEM (Ref # 11012)	46098-004	1
BRACKET,ENGINE GUARD (Ref # 11034)	55016-007	1
FRAME-COMP (Ref # 32002)	32002-1858	1
GUARD,ENGINE (Ref # 55020)	55011-018	1
NUT,STEERING STEM LOCK,25MM (Ref # 92015)	92015-1382	1
RACE,UPPER BEARING (Ref # 92048)	92047-005	1
RACE,BEARING (Ref # 92048A)	92048-004	1
BOLT-UPSET-WP (Ref # 186)	186B0614	1
BALL-STEEL,3/16" (Ref # 600)	600A0600	1