

1989 KE100 PARTS DIAGRAM

Muffler

E1140-0065

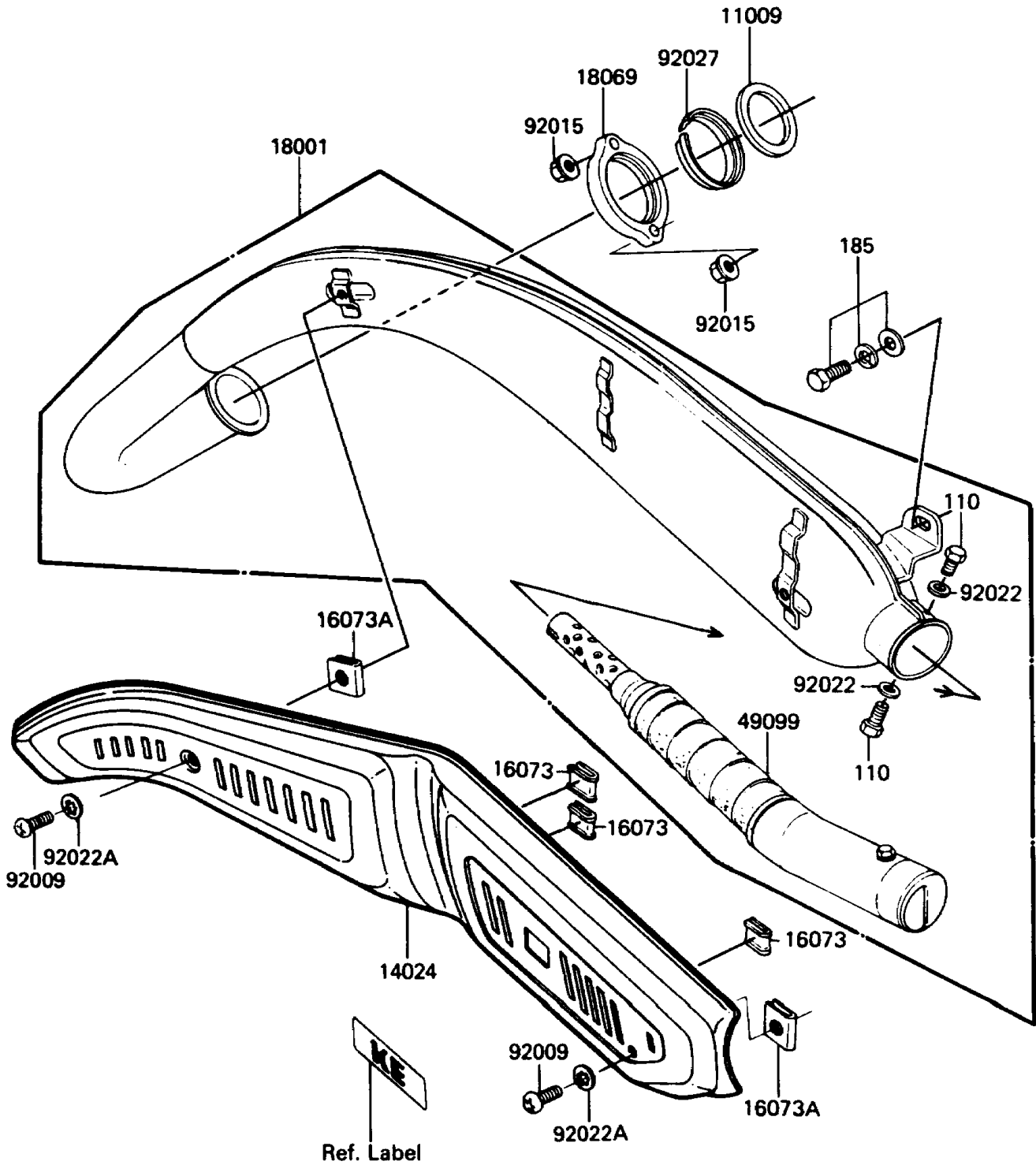

1989 KE100 PARTS LIST

Muffler

ITEM NAME	PART NUMBER	QUANTITY
GASKET,EXHAUST PIPE (Ref # 11009)	18067-003	1
COVER,MUFFLER,F.BLACK (Ref # 14024)	14025-1372	1
INSULATOR,HEAT (Ref # 16073)	18065-007	1
INSULATOR,HEAT (Ref # 16073A)	18065-009	1
MUFFLER (Ref # 18001)	18001-1603	1
HOLDER-EXHAUST PIPE (Ref # 18069)	18069-048	1
BAFFLE-PIPE MUFFLER (Ref # 49099)	18033-070	1
SCREW,6X12 (Ref # 92009)	92009-1309	1
NUT,6MM (Ref # 92015)	92015-1365	1
WASHER,6.1X12X1 (Ref # 92022)	92022-077	1
WASHER,TOOTHED,6MM (Ref # 92022A)	92022-1548	1
COLLAR,EXHAUST PIPE HOLDER (Ref # 92027)	18070-008	1
BOLT,6X14 (Ref # 110)	110B0614	1
BOLT-UPSET-WSP-SMALL (Ref # 185)	185C0816	1