

1988 KDX80 PARTS DIAGRAM

Rear Hub

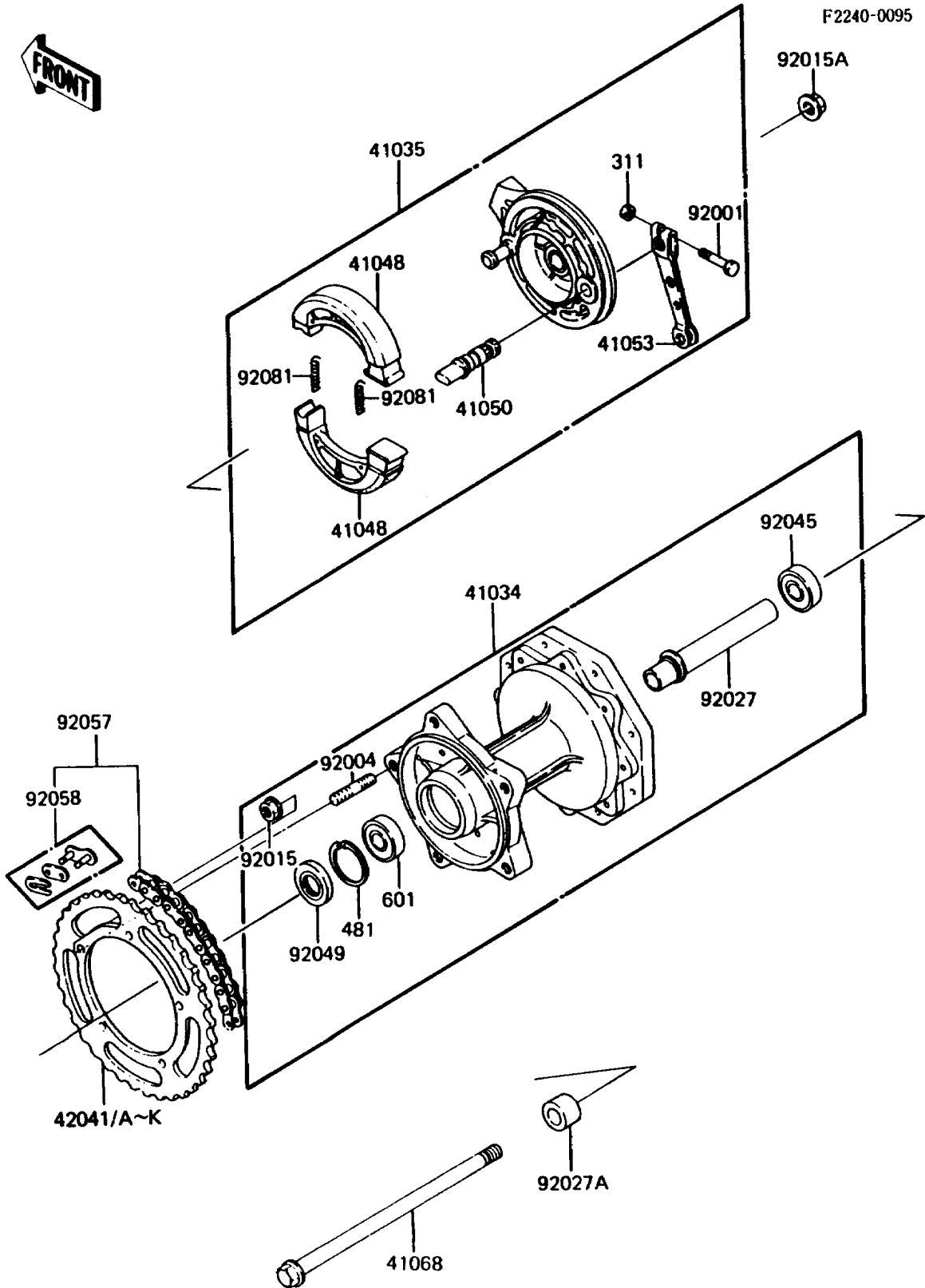

1988 KDX80 PARTS LIST

Rear Hub

ITEM NAME	PART NUMBER	QUANTITY
DRUM-ASSY,RR (Ref # 41034)	41034-1105	1
PANEL-ASSY-BRAKE,RR (Ref # 41035)	41035-1154	1
SHOE-BRAKE (Ref # 41048)	41048-1022	2
CAM-BRAKE (Ref # 41050)	41050-1031	1
LEVER-BRAKE CAM,RR (Ref # 41053)	41053-1058	1
AXLE,L=206 (Ref # 41068)	41068-1167	1
SPROCKET-HUB,44T (Ref # 42041)	42041-1114	1
SPROCKET-HUB,43T (Ref # 42041A)	42041-1116	1
SPROCKET-HUB,45T (Ref # 42041B)	42041-1117	1
SPROCKET-HUB,49T (Ref # 42041C)	42041-1121	1
SPROCKET-HUB,48T (Ref # 42041D)	42041-1122	1
SPROCKET-HUB,50T (Ref # 42041E)	42041-1123	1
SPROCKET-HUB,47T (Ref # 42041F)	42041-1129	1
SPROCKET-HUB,48T,AL (Ref # 42041G)	42041-1169	1
SPROCKET-HUB,49T,AL (Ref # 42041H)	42041-1170	1
SPROCKET-HUB,47T,AL (Ref # 42041I)	42041-1177	1
SPROCKET-HUB,46T (Ref # 42041J)	42041-1178	1
SPROCKET-HUB,51T (Ref # 42041K)	42041-1181	1
BOLT,5X25 (Ref # 92001)	92001-1695	1
STUD,8X16 (Ref # 92004)	92004-1053	5
NUT,8MM (Ref # 92015)	92015-1143	5
NUT,FLANGED,12MM (Ref # 92015A)	92015-1156	1
COLLAR,REAR DRUM,L=115 (Ref # 92027)	92027-1471	1
COLLAR,REAR AXLE,L=14.5 (Ref # 92027A)	92027-1473	1
BEARING-BALL,TMB201LLUC3/2A (Ref # 92045)	92045-1062	1
SEAL-OIL,DD20377 (Ref # 92049)	92049-1096	1
CHAIN,DRIVE,DID420MX118L (Ref # 92057)	92057-1154	1
JOINT-CHAIN (Ref # 92058)	92058-1053	1
SPRING,BRAKE SHOE (Ref # 92081)	92081-1766	2

1988 KDX80 PARTS LIST

Rear Hub

ITEM NAME	PART NUMBER	QUANTITY
NUT-HEX (Ref # 311)	311G0500	1
CIRCLIP-TYPE-C,37MM (Ref # 481)	481J3700	1
BEARING-BALL,#6201UUC3 (Ref # 601)	601B6301UU	1