

# 2002 KDX220R PARTS DIAGRAM

Clutch

E1350

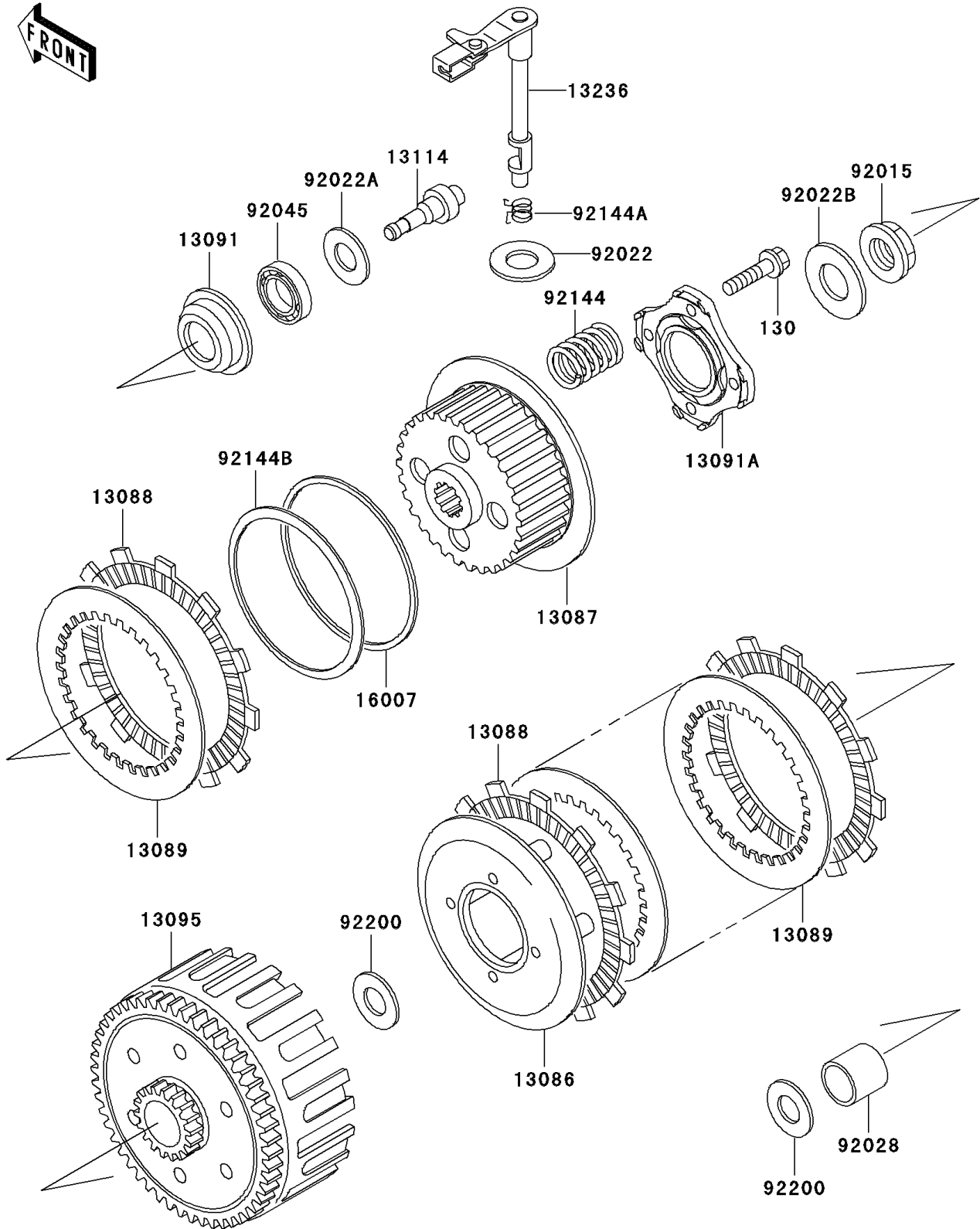

## 2002 KDX220R PARTS LIST

### Clutch

ITEM NAME	PART NUMBER	QUANTITY
BOLT-FLANGED (Ref # 130)	130Y0625	4
WHEEL-CLUTCH (Ref # 13086)	13086-1069	1
HUB-CLUTCH (Ref # 13087)	13087-1158	1
PLATE-FRICTION (Ref # 13088)	13088-1085	8
PLATE-CLUTCH (Ref # 13089)	13089-1076	7
HOLDER,CLUTCH PUSHER (Ref # 13091)	13091-1712	1
HOLDER,CLUTCH SPRING (Ref # 13091A)	13091-1872	1
HOUSING-COMP-CLUTCH (Ref # 13095)	13095-1287	1
PUSHER-CLUTCH (Ref # 13114)	13114-1067	1
LEVER-COMP,CLUTCH RELEASE (Ref # 13236)	13236-1264	1
SEAT-SPRING (Ref # 16007)	16007-1162	1
NUT,16MM (Ref # 92015)	92015-1581	1
WASHER,12.5X21X1.2 (Ref # 92022)	92022-072	1
WASHER,10.2X14.5X1.0 (Ref # 92022A)	92022-1181	AR
WASHER,16.3X29X1.75 (Ref # 92022B)	92022-1356	1
BUSHING,20X25X26.85 (Ref # 92028)	92028-1388	1
BEARING-BALL,6000 (Ref # 92045)	92045-1225	1
SPRING,CLUTCH (Ref # 92144)	92144-1160	4
SPRING,CLUTCH RELEASE (Ref # 92144A)	92144-1287	1
SPRING (Ref # 92144B)	92144-1522	1
WASHER,20.3X30X2.3 (Ref # 92200)	92200-1238	2