

# 1998 KDX220R PARTS DIAGRAM

Handlebar

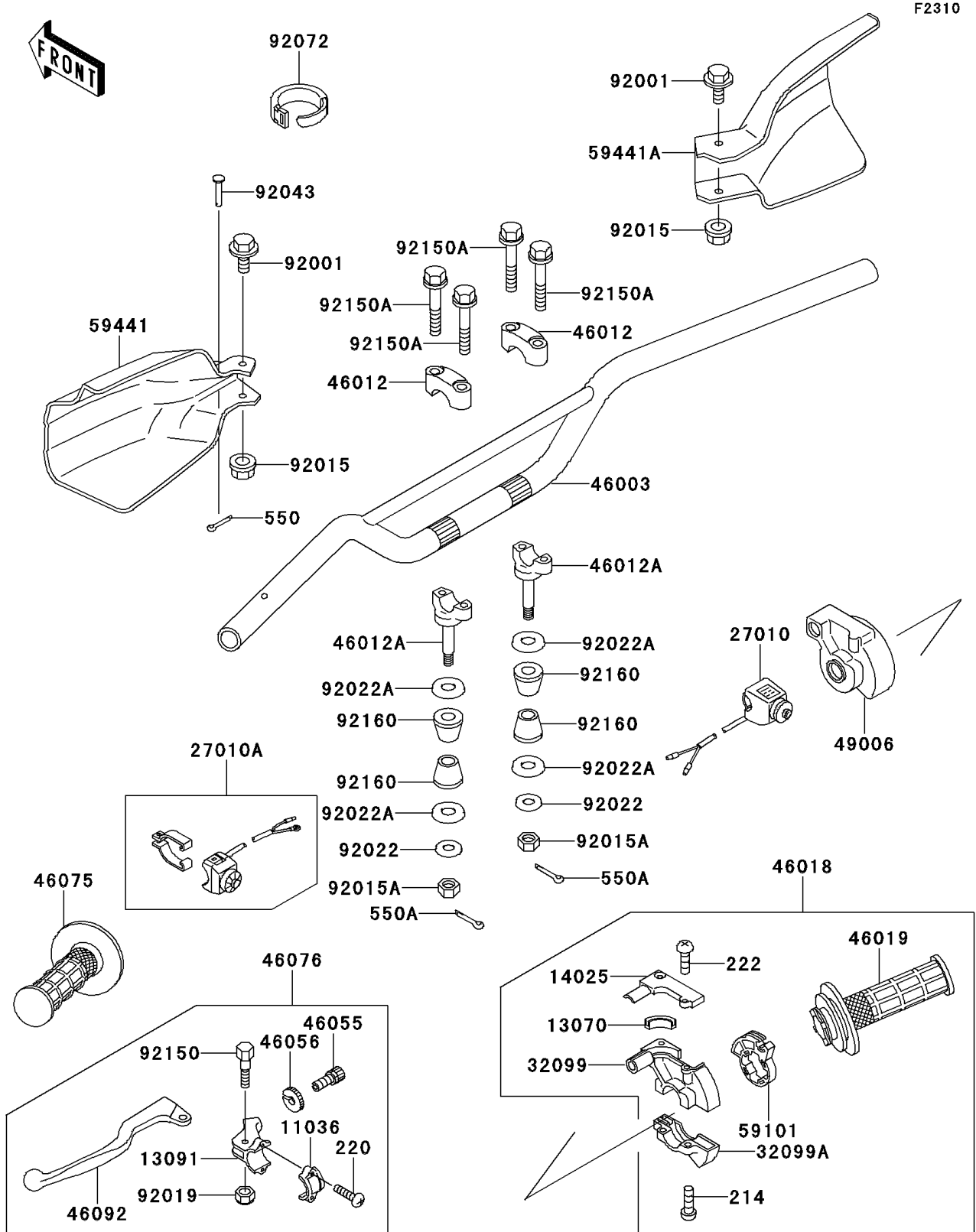

# 1998 KDX220R PARTS LIST

## Handlebar

ITEM NAME	PART NUMBER	QUANTITY
SCREW-PAN+- (Ref # 214)	214C0518	2
SCREW-PAN-CROS (Ref # 220)	220C0514	2
SCREW-CSK-RD-CROS (Ref # 222)	222E0412	2
PIN-COTTER,1.2X10 (Ref # 550)	550D1210	1
PIN-COTTER,2.0X20 (Ref # 550A)	550D2020	2
BRACKET-A,LEVER HOLDER (Ref # 11036)	11036-1297	1
GUIDE,THROTTLE PEACE (Ref # 13070)	13070-1073	1
HOLDER,CLUTCH LEVER (Ref # 13091)	13091-1131	1
COVER,THROTTLE CASE UPP (Ref # 14025)	14025-1646	1
SWITCH,LIGHTING (Ref # 27010)	27010-1279	1
SWITCH,ENGINE STOP (Ref # 27010A)	27010-1350	1
CASE,THROTTLE UPP (Ref # 32099)	32099-1036	1
CASE,THROTTLE LWR (Ref # 32099A)	32099-1044	1
HANDLE,SILVER NO.25 (Ref # 46003)	46003-1399-CE	1
HOLDER-HANDLE,UPP (Ref # 46012)	46012-1191	2
HOLDER-HANDLE,LWR (Ref # 46012A)	46012-1263	2
GRIP-ASSY-THROTTLE (Ref # 46018)	46018-1161	1
GRIP-ASSY,THROTTLE (Ref # 46019)	46019-1054	1
SCREW,CABLE ADJUST,8MM (Ref # 46055)	46055-009	1
NUT,CABLE ADJUST (Ref # 46056)	46056-006	1
GRIP,LH (Ref # 46075)	46075-1024	1
LEVER-ASSY-GRIP,CLUTCH (Ref # 46076)	46076-1163	1
LEVER-GRIP,CLUTCH (Ref # 46092)	46092-1110	1
BOOT,THROTTLE CASE (Ref # 49006)	49006-1097	1
REEL,THROTTLE (Ref # 59101)	59101-1103	1
COVER-HANDLE,LH,L.GREEN (Ref # 59441)	59441-1094-6W	1
COVER-HANDLE,RH,L.GREEN (Ref # 59441A)	59441-1108-6W	1
BOLT,FLANGED,6X10 (Ref # 92001)	92001-1034	2
NUT,LOCK,FLANGED,6MM (Ref # 92015)	92015-1603	2

# 1998 KDX220R PARTS LIST

## Handlebar

ITEM NAME	PART NUMBER	QUANTITY
NUT,LOCK,10MM (Ref # 92015A)	92015-1962	2
NUT,LOCK,6MM (Ref # 92019)	92019-008	1
WASHER,10.2X28X2 (Ref # 92022)	92022-1088	2
WASHER (Ref # 92022A)	92022-1737	4
PIN,5X27.5 (Ref # 92043)	92043-1434	1
BAND,L=140 (Ref # 92072)	92072-1293	2
BOLT (Ref # 92150)	92150-1291	1
BOLT,FLANGED,8X35 (Ref # 92150A)	92150-1696	4
DAMPER (Ref # 92160)	92160-1521	4