

1998 KDX220R PARTS DIAGRAM

Stand(s)

F2190

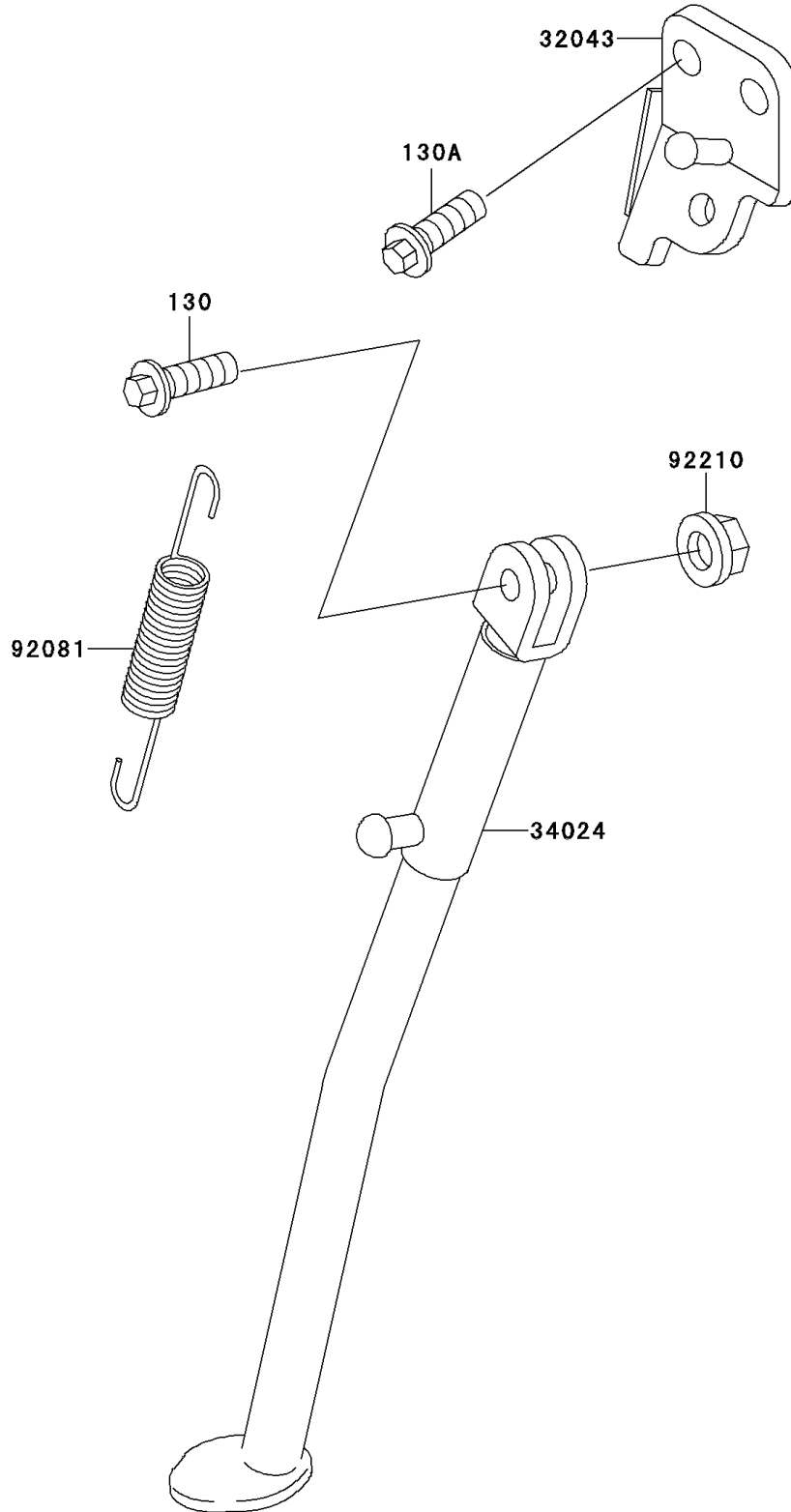

1998 KDX220R PARTS LIST

Stand(s)

ITEM NAME	PART NUMBER	QUANTITY
BOLT-FLANGED,10X35 (Ref # 130)	130G1035	1
BOLT-FLANGED (Ref # 130A)	130G1225	2
BRACKET-STAND,SIDE (Ref # 32043)	32043-1363	1
STAND-SIDE (Ref # 34024)	34024-1279	1
SPRING (Ref # 92081)	92081-1419	1
NUT,LOCK,FLANGED,10MM (Ref # 92210)	92210-1080	1