

1999 KDX200 PARTS DIAGRAM

Engine Cover(s)

E1431

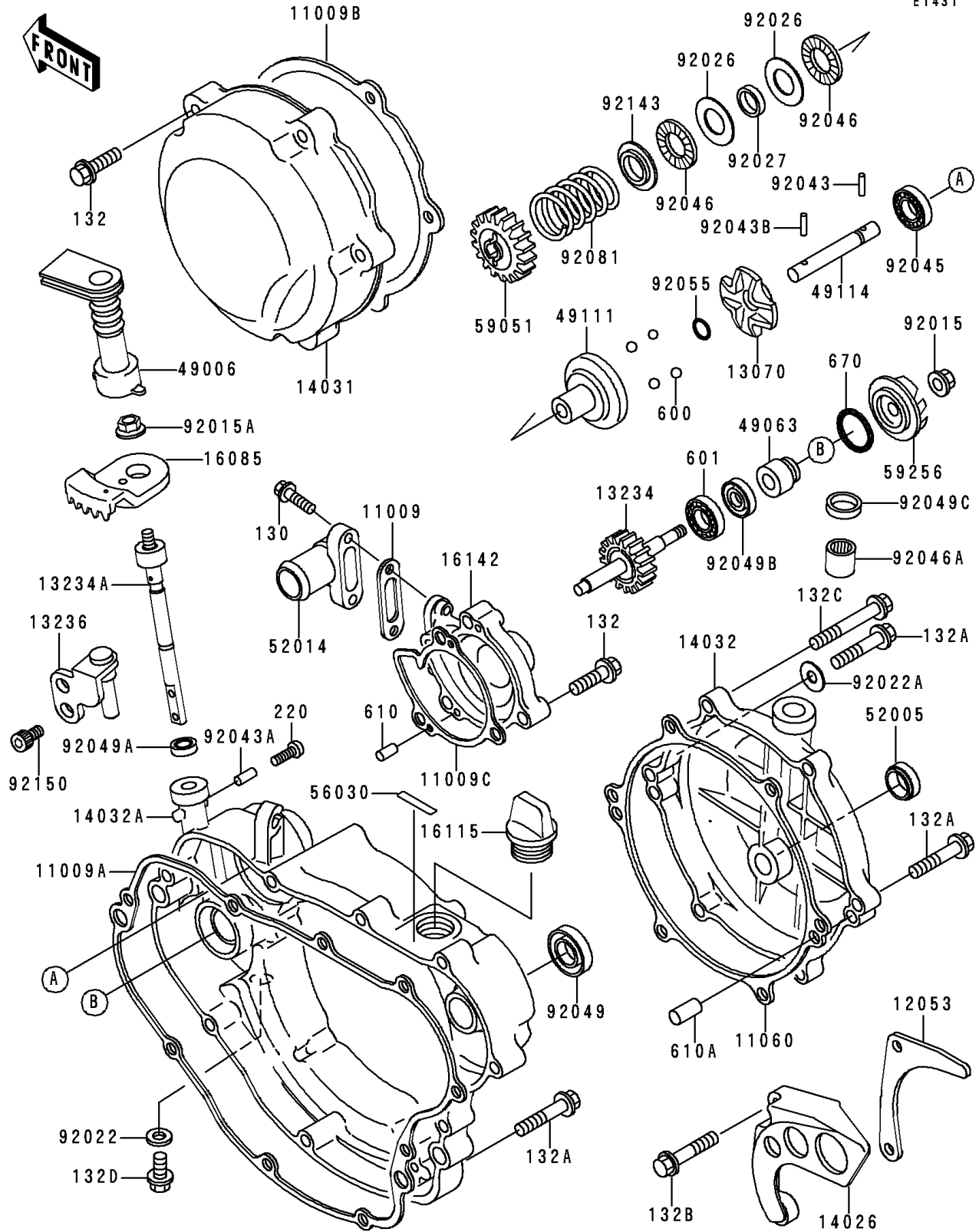

1999 KDX200 PARTS LIST

Engine Cover(s)

ITEM NAME	PART NUMBER	QUANTITY
GASKET,ELBOW (Ref # 11009)	11009-1952	1
GASKET,CLUTCH COVER (Ref # 11009A)	11009-1996	1
GASKET,GENERATOR COVER (Ref # 11009B)	11009-1997	1
GASKET,WATER PUMP COVER (Ref # 11009C)	11009-1998	1
GASKET,CLUTCH COVER (Ref # 11060)	11060-1630	1
GUIDE-CHAIN (Ref # 12053)	12053-1228	1
GUIDE (Ref # 13070)	13070-1122	1
SHAFT-COMP,PUMP (Ref # 13234)	13234-1091	1
SHAFT-COMP,GOVERNOR (Ref # 13234A)	13234-1101	1
LEVER-COMP,GOVERNOR (Ref # 13236)	13236-1260	1
COVER-CHAIN (Ref # 14026)	14026-1159	1
COVER-GENERATOR (Ref # 14031)	14031-1231	1
COVER-CLUTCH,OUT (Ref # 14032)	14032-1382	1
COVER-CLUTCH (Ref # 14032A)	14032-1418	1
GEAR (Ref # 16085)	16085-1273	1
CAP-OIL FILLER (Ref # 16115)	16115-018	1
COVER-PUMP (Ref # 16142)	16142-1090	1
BOOT,GOVERNOR SHAFT (Ref # 49006)	49006-1291	1
SEAL-MECHANICAL,WATER PUMP (Ref # 49063)	49063-1002	1
HOLDER-GOVERNOR WEIGHT (Ref # 49111)	49111-1051	1
SHAFT-GOVERNOR (Ref # 49114)	49114-1058	1
GAUGE,OIL LEVEL (Ref # 52005)	52005-1055	1
ELBOW (Ref # 52014)	52014-1067	1
LABEL,CLUTCH COVER,0.70L (Ref # 56030)	56030-1150	1
GEAR-SPUR,GOVERNOR,18T (Ref # 59051)	59051-1189	1
IMPELLER (Ref # 59256)	59256-1063	1
NUT,6MM (Ref # 92015)	92015-1365	1
NUT,6MM (Ref # 92015A)	92015-1572	1
WASHER,8.2X14X1.0 (Ref # 92022)	92022-1488	1

1999 KDX200 PARTS LIST

Engine Cover(s)

ITEM NAME	PART NUMBER	QUANTITY
WASHER,6.2X11X1 (Ref # 92022A)	92022-304	1
SPACER,15X28X1 (Ref # 92026)	92026-1238	1
COLLAR,15.2X17X4 (Ref # 92027)	92027-1839	1
PIN,3X12.8 (Ref # 92043)	92043-1256	1
PIN,2X9.8 (Ref # 92043A)	92043-1293	1
PIN,3X19.8 (Ref # 92043B)	92043-1319	1
BEARING-BALL,608MC3 (Ref # 92045)	92045-1305	1
BEARING-NEEDLE,AXK1102 (Ref # 92046)	92046-1052	1
BEARING-NEEDLE (Ref # 92046A)	92046-1230	1
SEAL-OIL,SB18307 (Ref # 92049)	92049-013	1
SEAL-OIL,SD08144 (Ref # 92049A)	92049-1207	1
BOLT-FLANGED (Ref # 130)	130Z0520	1
BOLT-FLANGED-SMALL (Ref # 132)	132Y0625	1
BOLT-FLANGED-SMALL (Ref # 132A)	132Y0630	1
BOLT-FLANGED-SMALL (Ref # 132B)	132Y0640	1
BOLT-FLANGED-SMALL (Ref # 132C)	132Y0680	1
BOLT-FLANGED-SMALL (Ref # 132D)	132Y0810	1
SCREW-PAN-CROS (Ref # 220)	220B0306	1
BALL-STEEL,5/16" (Ref # 600)	600A1000	1
BEARING-BALL,#6201LUC3/2A (Ref # 601)	601B6201U	1
ROLLER,4X8 (Ref # 610)	610A0408	1
ROLLER,6X12 (Ref # 610A)	610A0612	1
O RING,6MM (Ref # 670)	670B1506	1
SEAL-OIL,SC12 28.555 (Ref # 92049B)	92049-1259	1
SEAL-OIL (Ref # 92049C)	92049-1262	1
RING-O,5.5X1.5 (Ref # 92055)	92055-1343	1
SPRING,GOVERNOR (Ref # 92081)	92081-1769	1
COLLAR (Ref # 92143)	92143-1001	1
BOLT,SOCKET,4X8 (Ref # 92150)	92150-1888	1