

1986 KDX200 PARTS DIAGRAM

Crankcase

E1411-0159

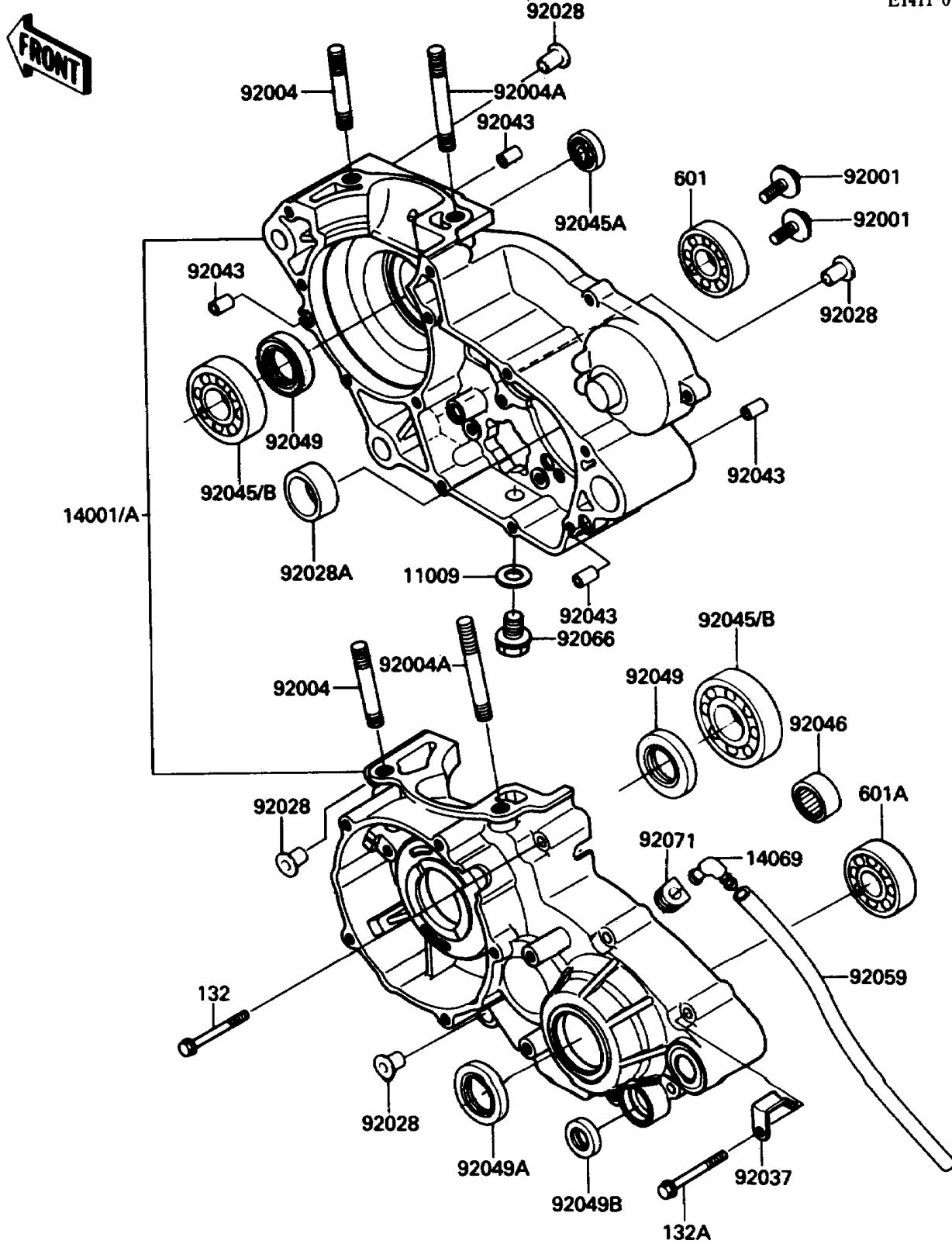

1986 KDX200 PARTS LIST

Crankcase

ITEM NAME	PART NUMBER	QUANTITY
GASKET,10.5X16X1,DRAIN PLUG (Ref # 11009)	92065-058	1
SET-CRANKCASE (Ref # 14001)	14001-5209	1
BREATHER,CRANKCASE (Ref # 14069)	14069-002	1
BOLT,FLANGED,6X18 (Ref # 92001)	92001-1066	2
STUD,8X25 (Ref # 92004)	92004-1008	2
STUD,8X60 (Ref # 92004A)	92004-1132	2
BUSHING (Ref # 92028)	92028-1133	4
BUSHING,23X30X13 (Ref # 92028A)	92028-132	1
CLAMP,HARNESS (Ref # 92037)	92037-1318	1
PIN,DOWEL,6.3X8X14 (Ref # 92043)	92042-007	4
BEARING-BALL,#6305SH2 (Ref # 92045)	92045-1024	2
BEARING-BALL,#608 (Ref # 92045A)	92045-1048	1
BEARING-NEEDLE,#7E-HKS162412-1 (Ref # 92046)	92046-026	1
SEAL-OIL,TBJ25407 (Ref # 92049)	92049-1068	2
SEAL-OIL,TB3040 (Ref # 92049A)	92050-033	1
SEAL-OIL,TB13225.5 (Ref # 92049B)	92051-005	1
TUBE,6X9X500 (Ref # 92059)	92059-1125	1
PLUG,DRAIN (Ref # 92066)	92066-1241	1
GROMMET,BREATHER (Ref # 92071)	92071-042	1
BOLT-FLANGED-SMALL (Ref # 132)	132G0640	10
BOLT-FLANGED-SMALL (Ref # 132A)	132G0660	1
BEARING-BALL,#6204C3 (Ref # 601)	601B6204	1
BEARING-BALL,#6205C3 (Ref # 601A)	601B6205	1