

1990 KD80 PARTS DIAGRAM

Crankshaft/Piston(s)

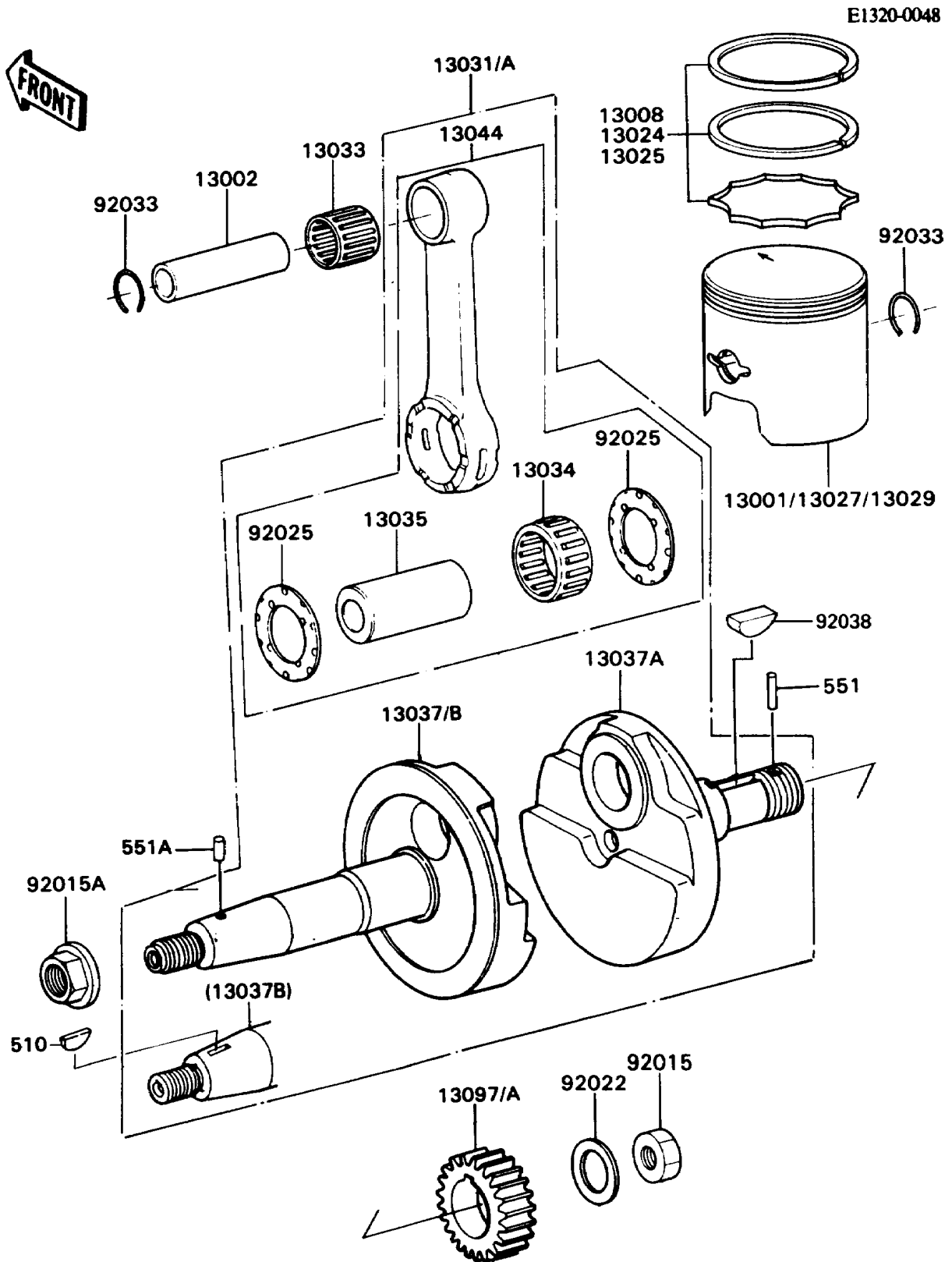

1990 KD80 PARTS LIST

Crankshaft/Piston(s)

ITEM NAME	PART NUMBER	QUANTITY
PISTON-ENGINE,STD (Ref # 13001)	13001-1281	1
PIN-PISTON (Ref # 13002)	13002-1076	1
RING-SET-PISTON,STD (Ref # 13008)	13008-1123	1
RING-SET-PISTON LL,O/S 1.00 (Ref # 13024)	13024-1084	1
RING-SET-PISTON L,O/S 0.50 (Ref # 13025)	13025-1098	1
PISTON-ENGINE LL,O/S 1.00 (Ref # 13027)	13027-1155	1
PISTON-ENGINE L,O/S 0.50 (Ref # 13029)	13029-1178	1
CRANKSHAFT-COMP (Ref # 13031A)	13031-1295	1
BEARING-SMALL END (Ref # 13033)	13033-1009	1
BEARING-BIG END,PK18X24X11.8X3 (Ref # 13034)	13034-1029	1
PIN-CRANK (Ref # 13035)	13035-1055	1
CRANKSHAFT,RH (Ref # 13037A)	13037-1325	1
CRANKSHAFT,LH (Ref # 13037B)	13037-1376	1
SET-CONNECTING ROD (Ref # 13044)	13044-5020	1
GEAR-PRIMARY SPUR,21T (Ref # 13097A)	13097-1228	1
NUT,LOCK,16MM (Ref # 92015)	92015-072	1
NUT,FLANGED,10MM (Ref # 92015A)	92015-077	1
WASHER,16.3X29X1.75 (Ref # 92022)	92022-1356	1
SHIM,CRANK SHAFT (Ref # 92025)	92025-1199	2
RING-SNAP,PISTON PIN (Ref # 92033)	92036-007	2
KEY,WOODRUFF (Ref # 92038)	92038-003	1
KEY-WOODRUFF (Ref # 510)	510A3200	1
PIN-DOWEL,2X12 (Ref # 551)	551A0212	1