

2005 900 STX PARTS DIAGRAM

Handle Pole

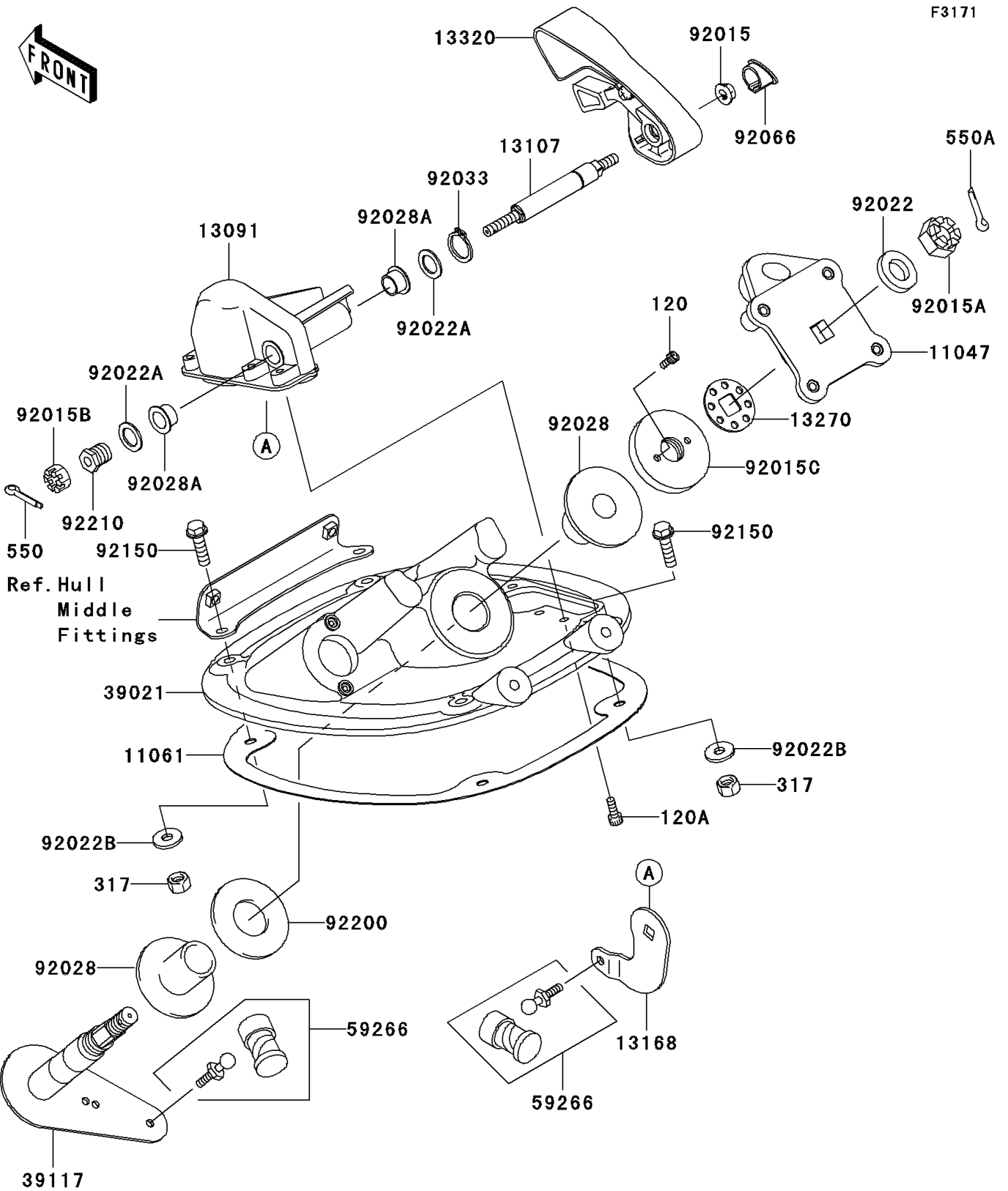

2005 900 STX PARTS LIST

Handle Pole

ITEM NAME	PART NUMBER	QUANTITY
BOLT-SOCKET,5X10 (Ref # 120)	120R0510	1
BOLT-SOCKET (Ref # 120A)	120R0616	1
NUT-HEX-SMALL (Ref # 317)	317R0800	1
PIN-COTTER (Ref # 550)	550S2020	1
PIN-COTTER,3X35 (Ref # 550A)	550S3035	1
BRACKET,HANDLE HOLDER (Ref # 11047)	11047-3759	1
GASKET,HANDLE POLE BRACKET (Ref # 11061)	11061-3735	1
HOLDER (Ref # 13091)	13091-3809	1
SHAFT (Ref # 13107)	13107-3751	1
LEVER,REVERSE (Ref # 13168)	13168-3750	1
PLATE,STEERING NUT (Ref # 13270)	13270-3808	1
LEVER-ASSY,REVERSE (Ref # 13320)	13320-3716	1
BRACKET-HANDLE POLE (Ref # 39021)	39021-3714	1
SHAFT-STRG (Ref # 39117)	39117-3713	1
JOINT-BALL (Ref # 59266)	59266-3707	1
NUT,FLANGED,8MM (Ref # 92015)	92015-3709	1
NUT,CASTLE,14MM (Ref # 92015A)	92015-3805	1
NUT,CASTLE,8MM (Ref # 92015B)	92015-3813	1
NUT,STEERING,20MM (Ref # 92015C)	92015-3854	1
WASHER,15X34X2.0 (Ref # 92022)	92022-3738	1
WASHER,15.5X24X1.5 (Ref # 92022A)	92022-3739	1
WASHER,8.4X23X2.5 (Ref # 92022B)	92022-3744	1
BUSHING,STEERING (Ref # 92028)	92028-3748	1
BUSHING (Ref # 92028A)	92028-3755	1
RING-SNAP,15MM (Ref # 92033)	92033-3710	1
PLUG,REVERSE LEVER (Ref # 92066)	92066-3761	1
BOLT,FLANGED,8X30 (Ref # 92150)	92150-3803	1
WASHER,32.5X70X2 (Ref # 92200)	92200-3718	1
NUT,8MM (Ref # 92210)	92210-3703	1