

2002 900 STX PARTS DIAGRAM

Crankcase

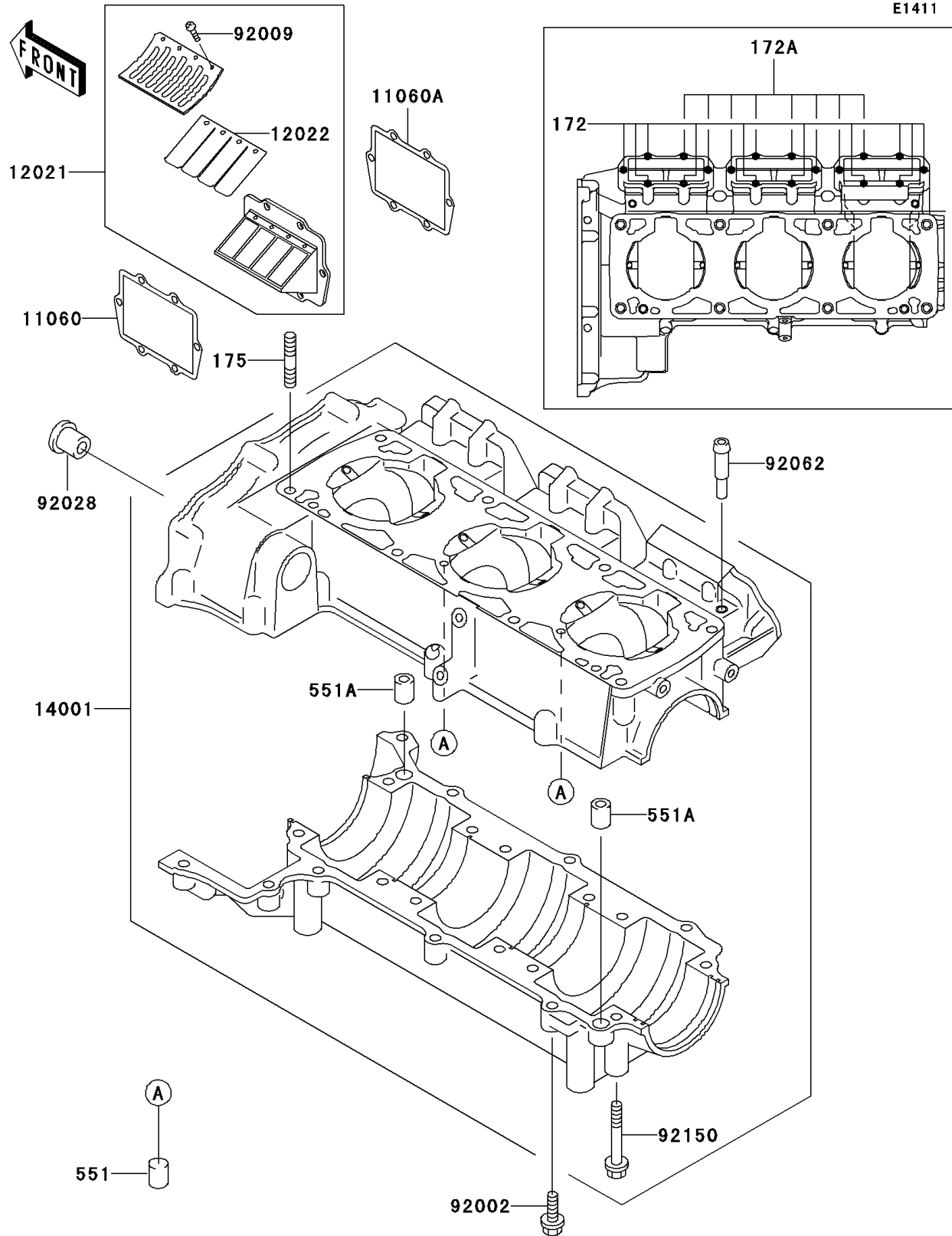

2002 900 STX PARTS LIST

Crankcase

ITEM NAME	PART NUMBER	QUANTITY
BOLT-STUD (Ref # 172)	172R0620	1
BOLT-STUD (Ref # 172A)	172R0630	1
BOLT-STUD-FINE (Ref # 175)	175R1035	1
PIN-DOWEL (Ref # 551)	551R0612	1
PIN-DOWEL (Ref # 551A)	551R1012	1
GASKET, REED VALVE (Ref # 11060)	11060-3717	1
GASKET, REED VALVE (Ref # 11060A)	11060-3757	1
VALVE-ASSY-REED (Ref # 12021)	12021-3709	1
VALVE-REED (Ref # 12022)	12022-3703	1
SET-CRANKCASE (Ref # 14001)	14001-5376	1
BOLT, 6X30 (Ref # 92002)	92002-3726	1
SCREW, 3X6 (Ref # 92009)	92009-1371	1
BUSHING (Ref # 92028)	92028-3718	1
NOZZLE (Ref # 92062)	92062-3705	1
BOLT, 8X65 (Ref # 92150)	92150-3708	1