

2000 Bayou 220 PARTS DIAGRAM

Crankcase

E1411

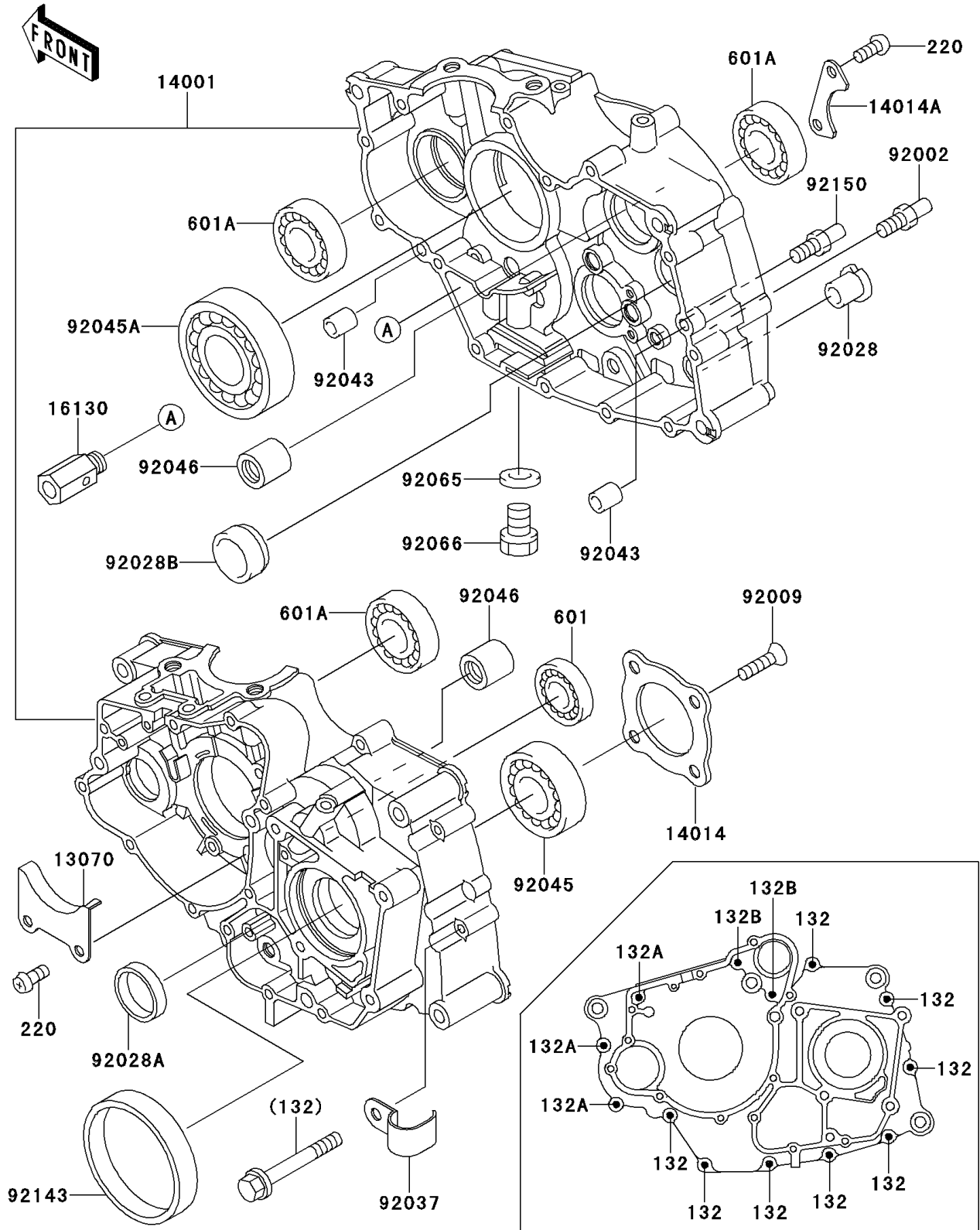

2000 Bayou 220 PARTS LIST

Crankcase

ITEM NAME	PART NUMBER	QUANTITY
BOLT-FLANGED-SMALL (Ref # 132)	132Y0640	8
BOLT-FLANGED-SMALL (Ref # 132A)	132Y0660	3
BOLT-FLANGED-SMALL (Ref # 132B)	132Y0675	2
SCREW-PAN-CROS,6X14 (Ref # 220)	220B0614	4
BEARING-BALL (Ref # 601)	601A6202Z	1
BEARING-BALL,#6204 (Ref # 601A)	601A6204	3
GUIDE,CAM CHAIN (Ref # 13070)	13070-1176	1
SET-CRANKCASE,W/PLUG (Ref # 14001)	14001-5323	1
PLATE-POSITION (Ref # 14014)	14014-1086	1
PLATE-POSITION (Ref # 14014A)	14014-1088	1
VALVE-ASSY-RELIEF (Ref # 16130)	16130-1001	1
BOLT,RETURN SPRING (Ref # 92002)	92002-1408	1
SCREW,6X14 (Ref # 92009)	92009-1349	4
BUSHING (Ref # 92028)	92028-1386	1
BUSHING,14X16X15 (Ref # 92028A)	92028-1505	1
BUSHING (Ref # 92028B)	92028-1506	1
CLAMP (Ref # 92037)	92037-1939	1
PIN,6.2X8X14 (Ref # 92043)	92043-1263	2
BEARING-BALL,TMB304CCM (Ref # 92045)	92045-1142	1
BEARING-BALL (Ref # 92045A)	92045-1172	1
BEARING-NEEDLE,HMK1515B (Ref # 92046)	92046-060	2
GASKET,12X22X2,DRAIN PLUG (Ref # 92065)	92065-097	1
PLUG,OIL DRAIN,12X15 (Ref # 92066)	92066-1174	1
COLLAR,66X70X11 (Ref # 92143)	92143-1120	1
BOLT,RETURN SPRING (Ref # 92150)	92150-1467	1