

1998 900 STX PARTS DIAGRAM

Electrical Equipment

F3181

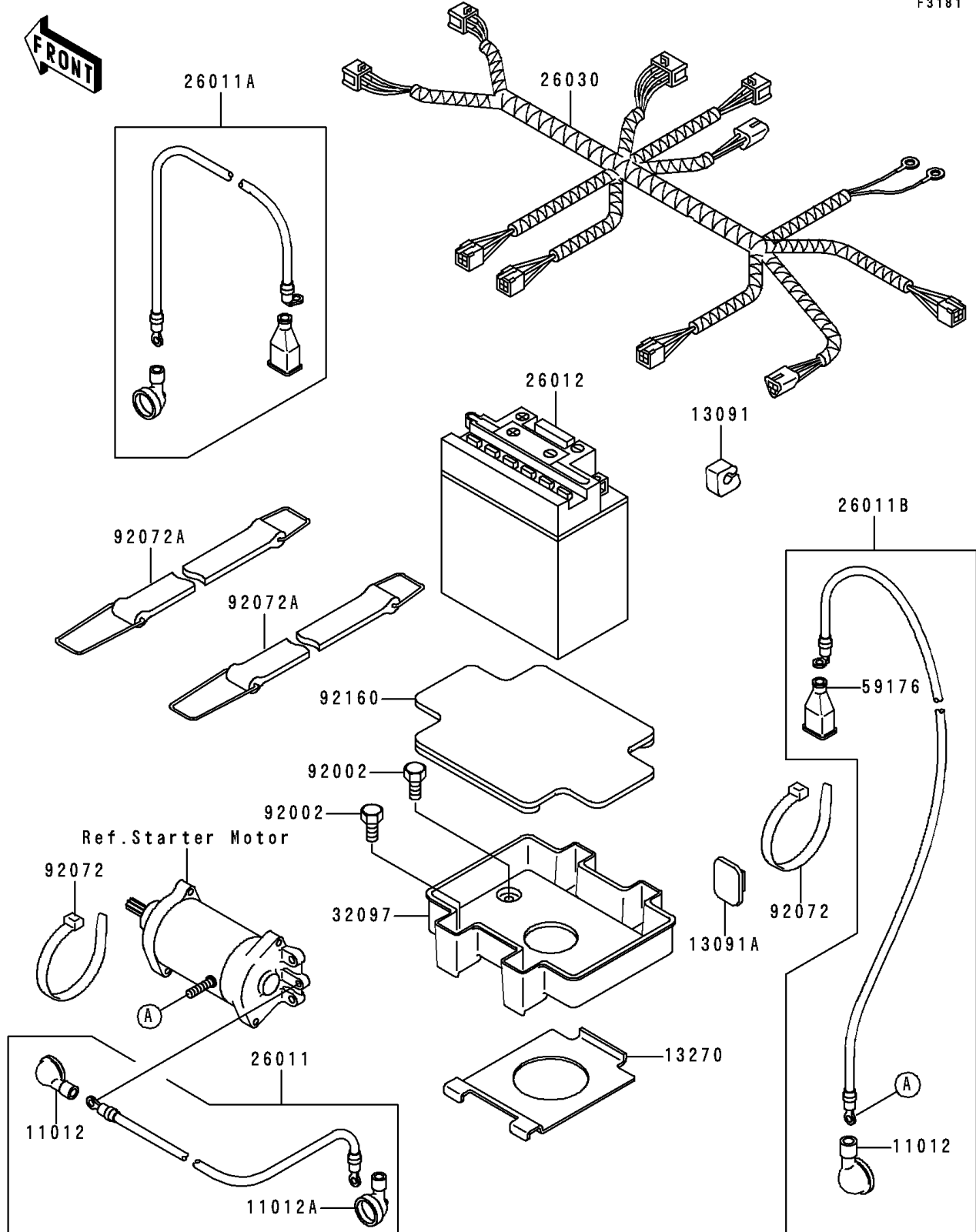

1998 900 STX PARTS LIST

Electrical Equipment

ITEM NAME	PART NUMBER	QUANTITY
CAP (Ref # 11012)	11012-3004	1
CAP,LEAD WIRE (Ref # 11012A)	11012-3726	1
HOLDER (Ref # 13091)	13091-3712	1
HOLDER,BAND (Ref # 13091A)	13091-3764	1
PLATE,BATTERY (Ref # 13270)	13270-3879	1
WIRE-LEAD,RELAY-STARTER (Ref # 26011)	26011-3797	1
WIRE-LEAD,RELAY-BATTERY (Ref # 26011A)	26011-3846	1
WIRE-LEAD,STARTER-BATTERY (Ref # 26011B)	26011-3848	1
BATTERY,YTX20L-BS,12V 18AH (Ref # 26012)	26012-3725	1
HARNESS,MAIN (Ref # 26030)	26030-3712	1
CASE-BATTERY (Ref # 32097)	32097-3703	1
CAP.,TERMINAL (Ref # 59176)	59176-501	1
BOLT,6X16 (Ref # 92002)	92002-3728	1
BAND (Ref # 92072)	92072-3778	1
BAND,BATTERY (Ref # 92072A)	92072-3805	1
DAMPER,BATTERY (Ref # 92160)	92160-3860	1