

# 1993 Bayou 220 PARTS DIAGRAM

## Battery Case

F2132

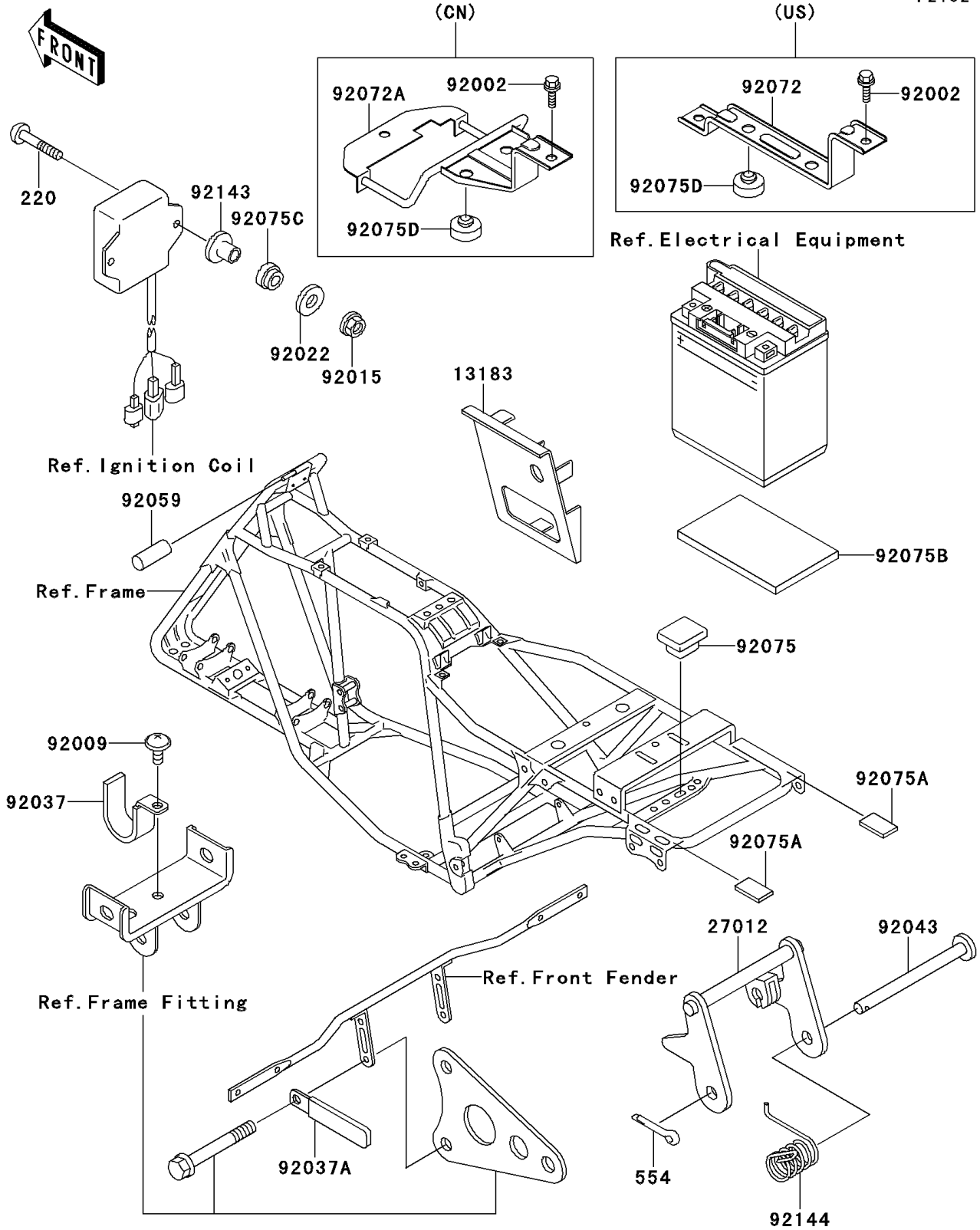

# 1993 Bayou 220 PARTS LIST

## Battery Case

ITEM NAME	PART NUMBER	QUANTITY
SCREW-PAN-CROS,6X25 (Ref # 220)	220B0625	2
PIN-SNAP (Ref # 554)	554A0600	1
PLATE,ELECTRIC BASE (Ref # 13183)	13183-1134	1
HOOK,SEAT (Ref # 27012)	27012-1381	1
BOLT,6X14 (Ref # 92002)	92002-1351	2
SCREW,6X14 (Ref # 92009)	92009-1288	1
NUT,LOCK,FLANGED,6MM (Ref # 92015)	92015-1675	2
WASHER,7X18X1.2 (Ref # 92022)	92022-1545	2
CLAMP (Ref # 92037)	92037-1700	1
CLAMP (Ref # 92037A)	92037-1780	1
PIN,6X77 (Ref # 92043)	92043-1367	1
TUBE,3X8X40 (Ref # 92059)	92059-1901	1
DAMPER (Ref # 92075)	92075-099	1
DAMPER (Ref # 92075A)	92075-1830	2
DAMPER (Ref # 92075C)	92075-208	2
DAMPER (Ref # 92075D)	92075-281	2
COLLAR,L=9.6 (Ref # 92143)	92143-1016	2
SPRING,SEAT HOOK (Ref # 92144)	92144-1174	1
BAND,BATTERY (Ref # 92072)	92072-1222	1
BAND,BATTERY (Ref # 92072A)	92072-1292	1
DAMPER,BATTERY (Ref # 92075B)	92075-1997	1