

2013 W800 (European) PARTS DIAGRAM

Valve(s)

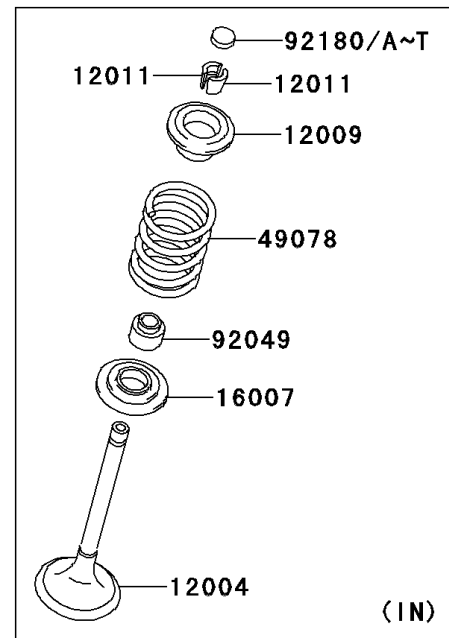
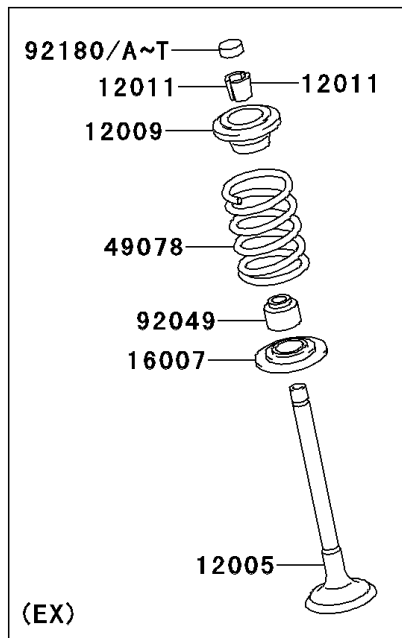
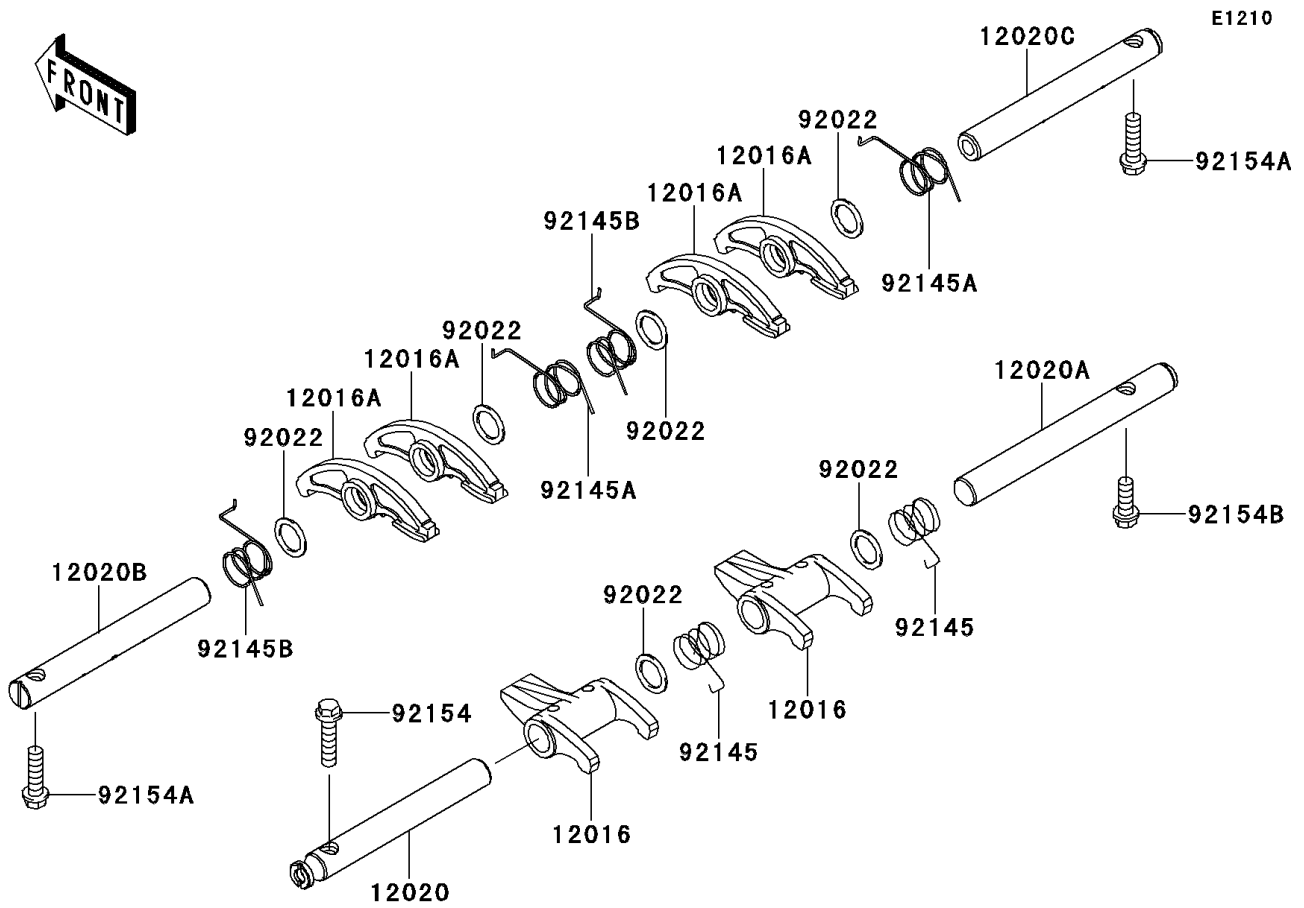

2013 W800 (European) PARTS LIST

Valve(s)

ITEM NAME	PART NUMBER	QUANTITY
VALVE-INTAKE (Ref # 12004)	12004-1138	4
VALVE-EXHAUST (Ref # 12005)	12005-1301	4
RETAINER-VALVE SPRING (Ref # 12009)	12009-1069	8
COLLET (Ref # 12011)	12011-1053	16
ARM-ROCKER,INTAKE (Ref # 12016)	12016-1116	2
ARM-ROCKER,EXHAUST (Ref # 12016A)	12016-1117	4
SHAFT-ROCKER,INTAKE,LH (Ref # 12020)	12020-1076	1
SHAFT-ROCKER,INTAKE,RH (Ref # 12020A)	12020-1077	1
SHAFT-ROCKER,EXHAUST,LH (Ref # 12020B)	12020-1078	1
SHAFT-ROCKER,EXHAUST,RH (Ref # 12020C)	12020-1079	1
SEAT-SPRING (Ref # 16007)	16007-1163	8
SPRING-ENGINE VALVE (Ref # 49078)	49078-1182	8
WASHER,13.2X20X0.5 (Ref # 92022)	92022-1224	6
SEAL-OIL,VS B 4.3 7.5 5.3 8.3 (Ref # 92049)	92049-1349	8
SPRING,ROCKER SHAFT,IN (Ref # 92145)	92145-1278	2
SPRING,ROCKER SHAFT,EX,RH (Ref # 92145A)	92145-1279	2
SPRING,ROCKER SHAFT,EX,LH (Ref # 92145B)	92145-1280	2
BOLT,FLANGED,6X25 (Ref # 92154)	92154-0479	1
BOLT,FLANGED,6X22 (Ref # 92154A)	92154-0480	2
BOLT,FLANGED,6X16 (Ref # 92154B)	92154-0481	1
SHIM,T=2.50 (Ref # 92180)	92180-1014	8
SHIM,T=2.55 (Ref # 92180A)	92180-1016	AR
SHIM,T=2.60 (Ref # 92180B)	92180-1018	AR
SHIM,T=2.65 (Ref # 92180C)	92180-1020	AR
SHIM,T=2.70 (Ref # 92180D)	92180-1022	AR
SHIM,T=2.75 (Ref # 92180E)	92180-1024	AR
SHIM,T=2.80 (Ref # 92180F)	92180-1026	AR
SHIM,T=2.85 (Ref # 92180G)	92180-1028	AR
SHIM,T=2.90 (Ref # 92180H)	92180-1030	AR

2013 W800 (European) PARTS LIST

Valve(s)

ITEM NAME	PART NUMBER	QUANTITY
SHIM,T=2.95 (Ref # 92180I)	92180-1032	AR
SHIM,T=3.00 (Ref # 92180J)	92180-1034	AR
SHIM,T=3.05 (Ref # 92180K)	92180-1036	AR
SHIM,T=3.10 (Ref # 92180L)	92180-1038	AR
SHIM,T=3.15 (Ref # 92180M)	92180-1040	AR
SHIM,T=3.20 (Ref # 92180N)	92180-1042	AR
SHIM,T=3.25 (Ref # 92180O)	92180-1044	AR
SHIM,T=3.30 (Ref # 92180P)	92180-1046	AR
SHIM,T=3.35 (Ref # 92180Q)	92180-1048	AR
SHIM,T=3.40 (Ref # 92180R)	92180-1050	AR
SHIM,T=3.45 (Ref # 92180S)	92180-1052	AR
SHIM,T=3.50 (Ref # 92180T)	92180-1054	AR