

2015 Ninja® 300 SE PARTS DIAGRAM

Gear Change Mechanism

E1370

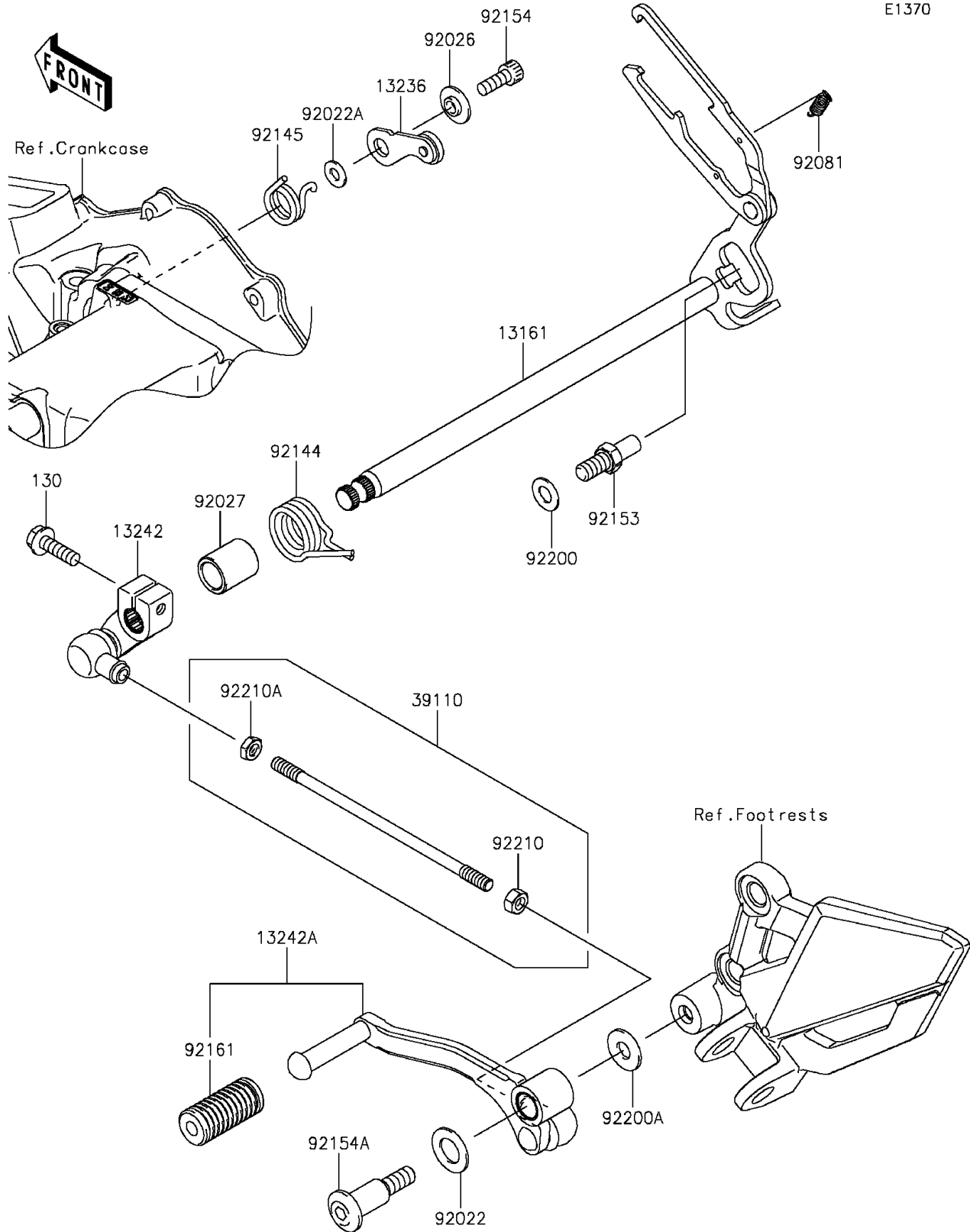

2015 Ninja® 300 SE PARTS LIST

Gear Change Mechanism

ITEM NAME	PART NUMBER	QUANTITY
BOLT-FLANGED,6X20 (Ref # 130)	130CB0620	1
LEVER-COMP-CHANGE SHAFT (Ref # 13161)	13161-0560	1
LEVER-COMP (Ref # 13236)	13236-0754	1
LEVER-ASSY-CHANGE (Ref # 13242)	13242-0087	1
LEVER-ASSY-CHANGE,PEDAL (Ref # 13242A)	13242-0088	1
ROD-ASSY-TIE (Ref # 39110)	39110-0307	1
WASHER,12.5X22X1.2 (Ref # 92022)	92022-072	1
WASHER,6X12.8X1.2 (Ref # 92022A)	92022-1827	1
SPACER (Ref # 92026)	92026-1217	1
COLLAR,13X18.3X21.5 (Ref # 92027)	92027-1440	1
SPRING,CHANGE LEVER (Ref # 92081)	92081-076	1
SPRING,CHANGE PEDAL RETURN (Ref # 92144)	92144-1074	1
SPRING (Ref # 92145)	92145-0895	1
BOLT,8X15.5 (Ref # 92153)	92153-1986	1
BOLT,SOCKET,6X16 (Ref # 92154)	92154-0235	1
BOLT (Ref # 92154A)	92154-1034	1
DAMPER,CHANGE PEDAL (Ref # 92161)	92161-1466	1
WASHER,8.2X16X1 (Ref # 92200)	92200-0434	1
WASHER,8.5X20X1.6 (Ref # 92200A)	92200-0490	1
NUT,6MM (Ref # 92210)	92210-0778	1
NUT,6MM (Ref # 92210A)	92210-0779	1