

2016 NINJA® 650 ABS PARTS DIAGRAM

Meter(s)

F2530

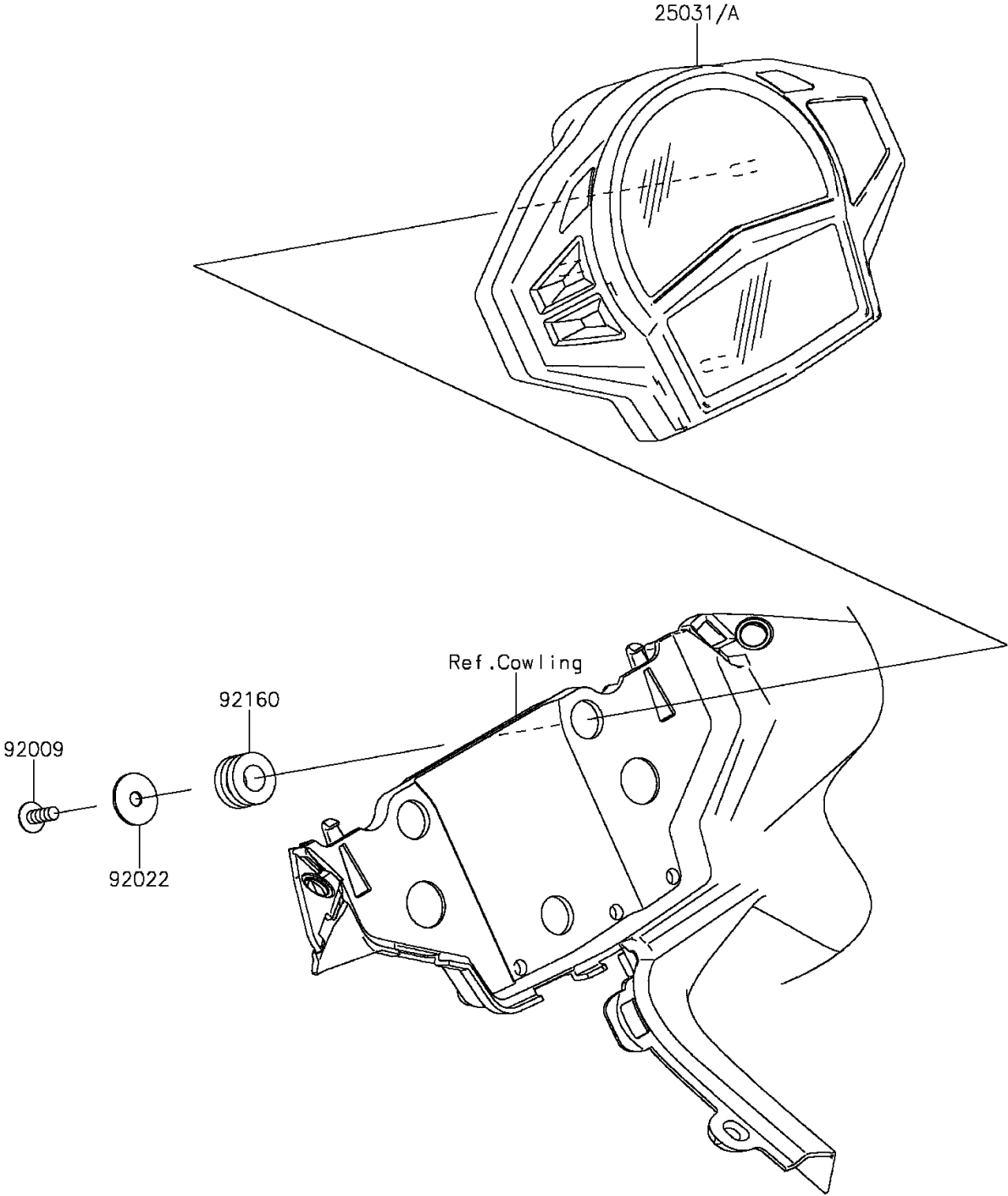

2016 NINJA® 650 ABS PARTS LIST

Meter(s)

ITEM NAME	PART NUMBER	QUANTITY
-----------	-------------	----------