

2000 KLR650 PARTS DIAGRAM

Headlight(s)

F2710

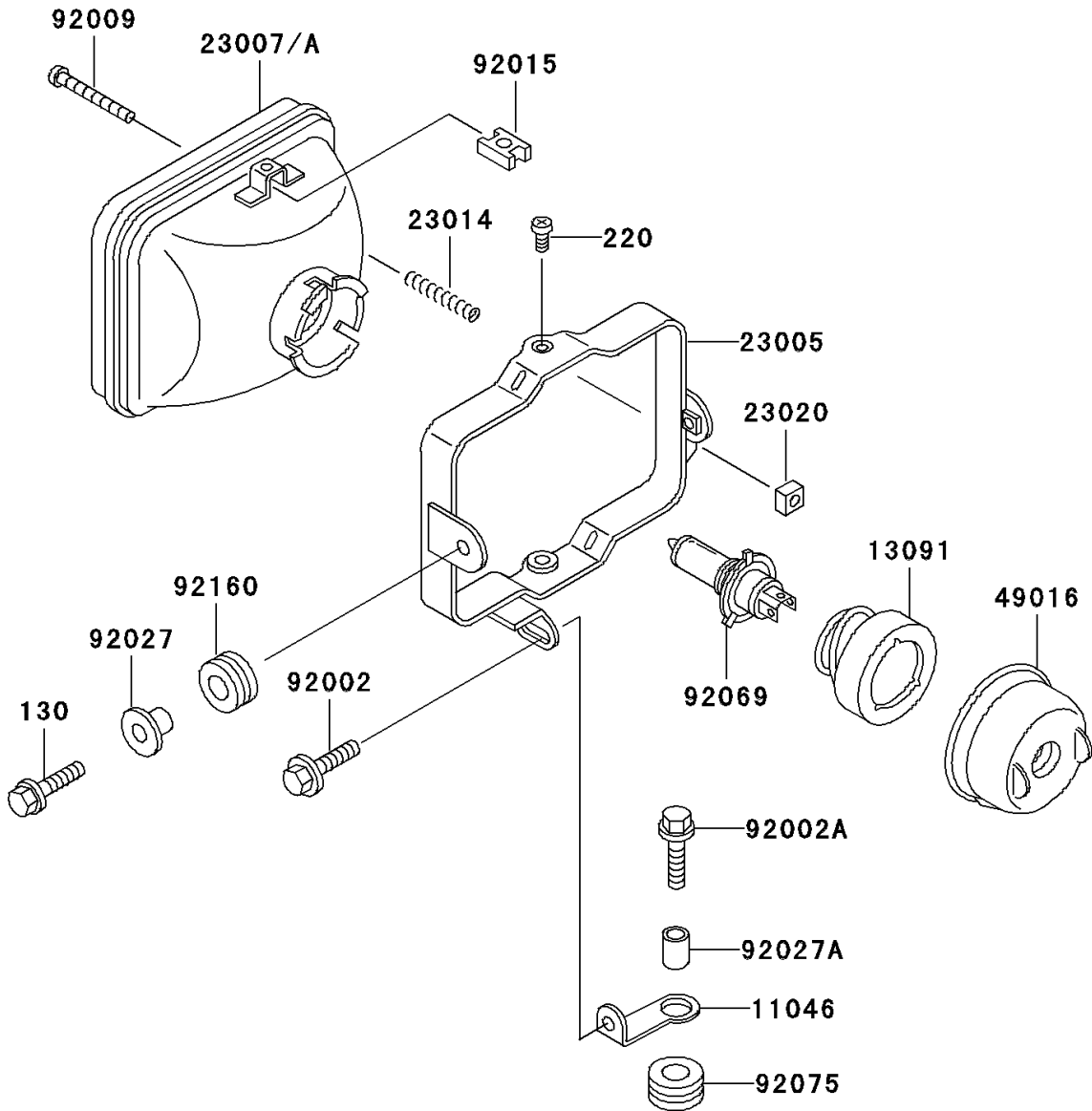

2000 KLR650 PARTS LIST

Headlight(s)

ITEM NAME	PART NUMBER	QUANTITY
BOLT-FLANGED,8X25 (Ref # 130)	130B0825	2
SCREW-PAN-CROS,5X8 (Ref # 220)	220B0508	2
BRACKET,HEAD LAMP (Ref # 11046)	11046-1041	1
BODY-COMP-HEAD LAMP (Ref # 23005)	23005-1052	1
LENS-COMP,HEAD LAMP (Ref # 23007A)	23007-1364	1
SPRING,FOCUS ADJUSTING (Ref # 23014)	23014-005	1
NUT,4MM,FOCUS ADJUST (Ref # 23020)	23020-018	1
COVER-SEAL,SOCKET (Ref # 49016)	49016-1037	1
BOLT,6X16 (Ref # 92002)	92002-1124	1
BOLT,6X25 (Ref # 92002A)	92002-1135	1
SCREW,4X48 (Ref # 92009)	92009-1065	1
NUT,5MM (Ref # 92015)	92015-1354	2
COLLAR,L=14 (Ref # 92027)	92027-1134	2
COLLAR,6.8X10X12 (Ref # 92027A)	92027-162	1
BULB,12V 60/55W,H4 (Ref # 92069)	92069-1002	1
DAMPER (Ref # 92075)	92075-209	1
DAMPER (Ref # 92160)	92160-1007	2