

1983 KX125 PARTS DIAGRAM

BRAKE PEDAL/TORQUE LINK (KX125-B1)

F2260-0070

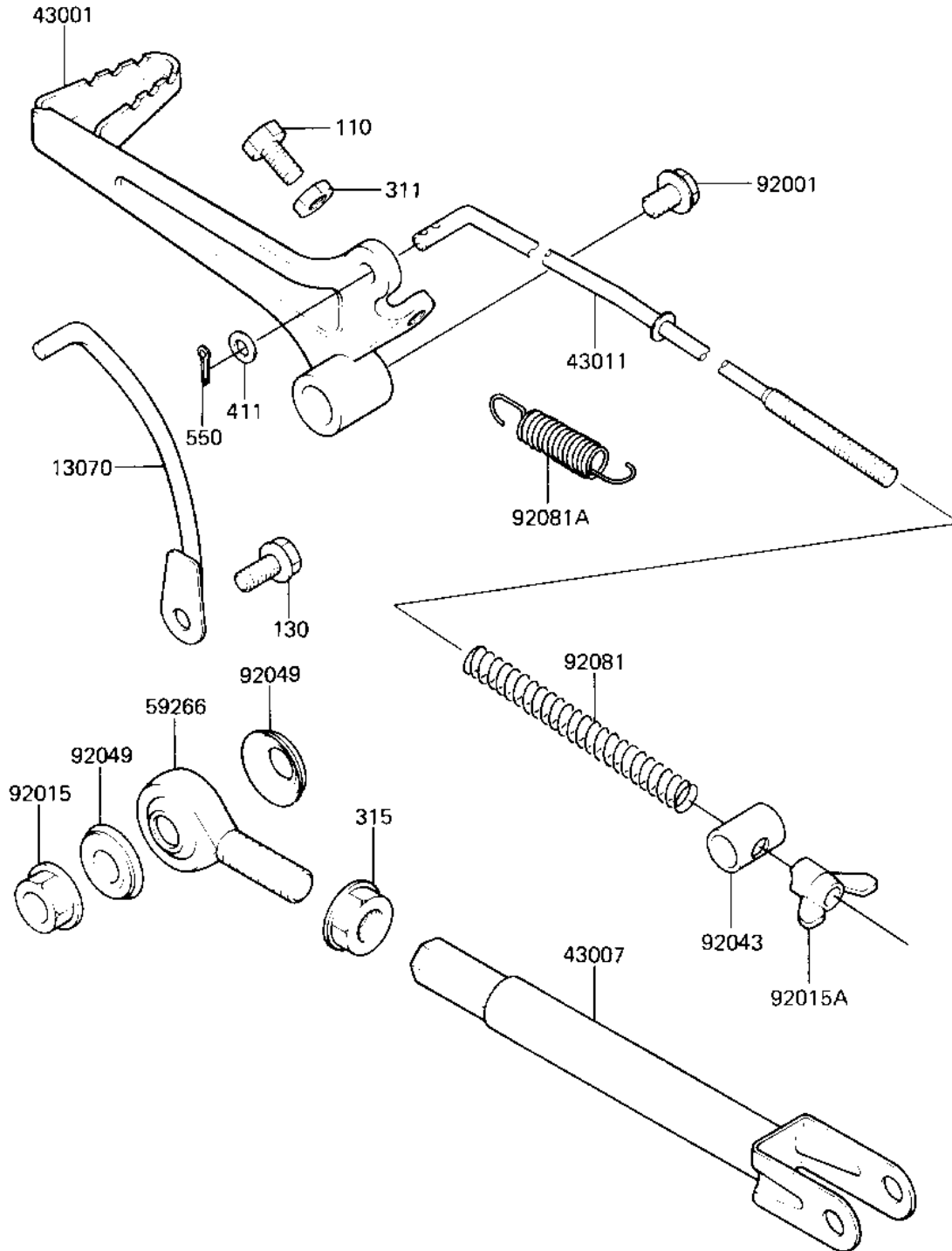

1983 KX125 PARTS LIST

BRAKE PEDAL/TORQUE LINK (KX125-B1)

ITEM NAME	PART NUMBER	QUANTITY
GUIDE,BRAKE ROD (Ref # 13070)	13070-1054	1
LEVER-BRAKE,PEDAL (Ref # 43001)	43001-1073	1
ROD-TORQUE (Ref # 43007)	43007-1031	1
ROD-BRAKE (Ref # 43011)	43011-1042	1
JOINT,BALL (Ref # 59266)	59266-1005	1
BOLT,HEX HEAD,6X10 (Ref # 92001)	92001-1034	1
NUT,10MM (Ref # 92015)	92015-1415	1
NUT,WING,6M/M (Ref # 92015A)	92015-4004	1
PIN,BRAKE (Ref # 92043)	92043-1024	1
OIL SEAL,BALL JOINT (Ref # 92049)	92049-1072	1
SPRING,BRAKE ROD (Ref # 92081)	43012-001	1
SPRING RETURN (Ref # 92081A)	92081-1059	1
BOLT-UPSET (Ref # 110)	112G0622	1
BOLT,FLANGED,6X12 (Ref # 130)	130G0612	1
NUT 6MM (Ref # 311)	311B0600	1
NUT 10MM (Ref # 315)	315G1000	1
WASHER PLAIN 6MM (Ref # 411)	411B0600	1
PIN COTTER 2.0X15 (Ref # 550)	550D2015	1