

## 1983 KX125 PARTS DIAGRAM

TRANSMISSION (KX125-B1)

E1361 0055

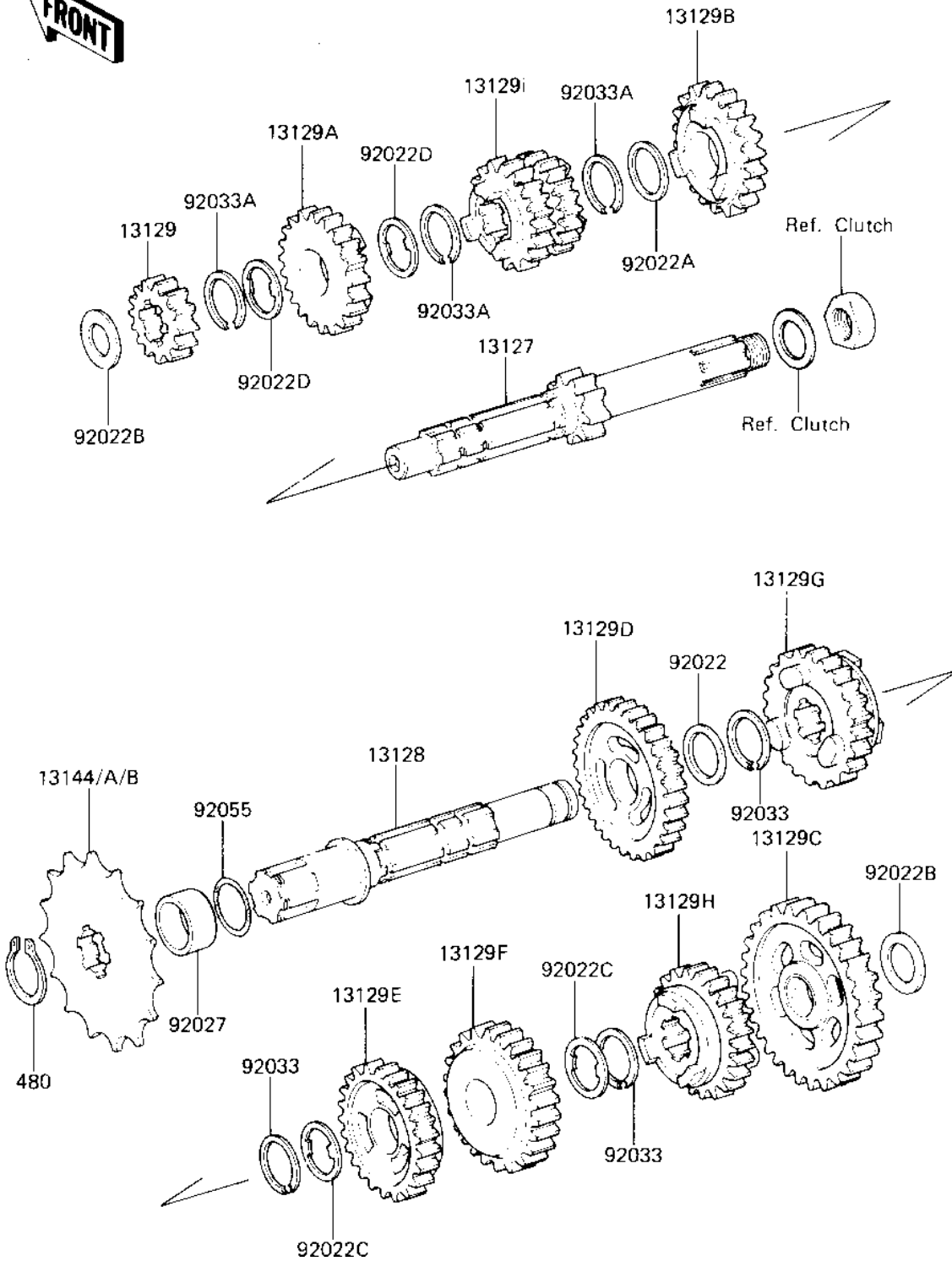

## 1983 KX125 PARTS LIST

TRANSMISSION (KX125-B1)

ITEM NAME	PART NUMBER	QUANTITY
SHAFT-TRANSMISSION IN (Ref # 13127)	13127-1045	1
SHAFT-TRANSMISSION OU (Ref # 13128)	13128-1038	1
GEAR,INPUT,2ND,16T (Ref # 13129)	13129-1300	1
GEAR,INPUT-5TH,24T (Ref # 13129A)	13129-1302	1
GEAR,INPUT,TOP,22T (Ref # 13129B)	13129-1303	1
GEAR,OUTPUT,LOW,30T (Ref # 13129C)	13129-1304	1
GEAR,OUTPUT,2ND,28T (Ref # 13129D)	13129-1305	1
GEAR,OUTPUT,3RD,28T (Ref # 13129E)	13129-1306	1
GEAR,OUTPUT,4TH,26T (Ref # 13129F)	13129-1307	1
GEAR,OUTPUT,5TH,25T (Ref # 13129G)	13129-1308	1
GEAR,OUTPUT,TOP,21T (Ref # 13129H)	13129-1309	1
GEAR,INPUT,3RD&4TH,20 (Ref # 13129I)	13129-1340	1
ENGINE SPROCKET,11T (Ref # 13144)	13144-1036	1
SPROCKET-OUTPUT,12T (Ref # 13144A)	13144-1049	1
SPROCKET-OUTPUT 13T (Ref # 13144B)	13144-1050	1
WASHER-PLAIN (Ref # 92022)	92022-198	1
WASHER (Ref # 92022A)	92022-252	1
WASHER,THRUST,15MM (Ref # 92022B)	92022-279	1
WASHER-LOCK (Ref # 92022C)	92024-039	1
WASHER,LOCK (Ref # 92022D)	92024-059	1
COLLAR,20X25X10.8 (Ref # 92027)	92027-1445	1
CIRCLIP,25MM (Ref # 92033)	92033-025	1
CIRCLIP,18MM (Ref # 92033A)	92033-029	1
"O" RING (Ref # 92055)	92055-022	1
CIRCLIP, 20MM (Ref # 480)	480J2000	1