

# 1984 KE100 PARTS DIAGRAM

## CHASSIS ELECTRICAL EQUIPMENT

F2760-0094

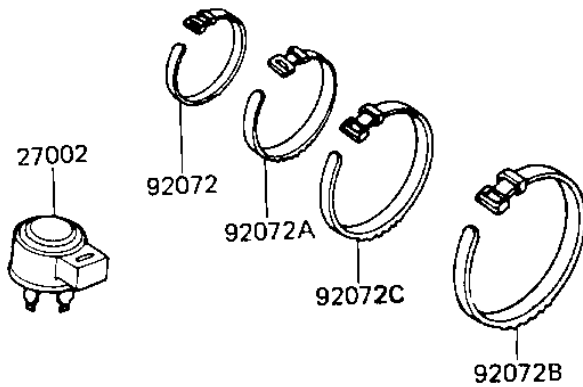
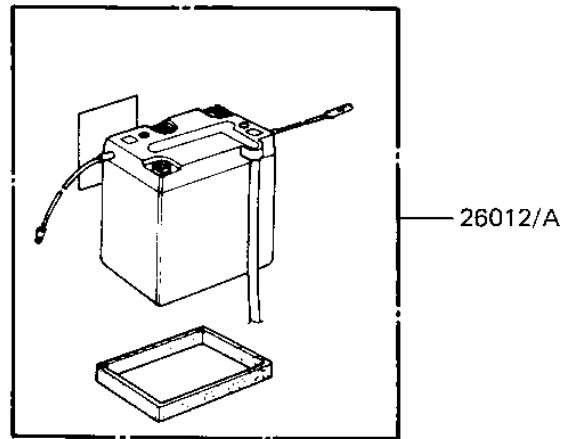
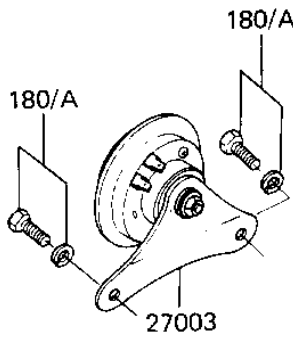
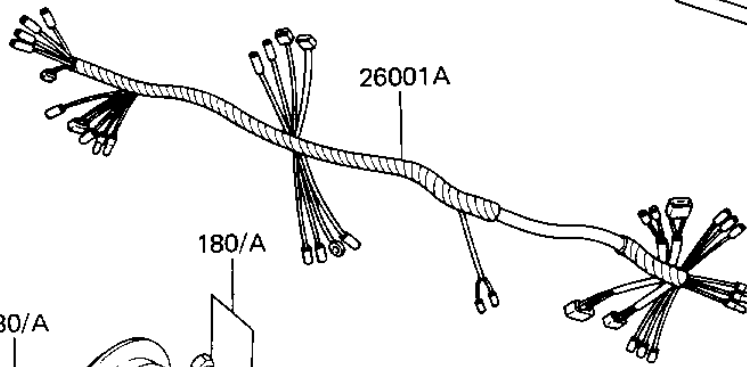
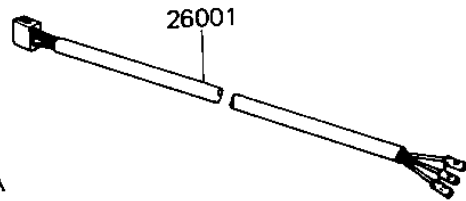
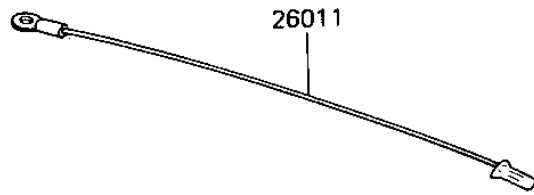
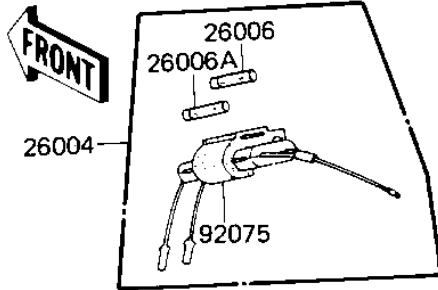

# 1984 KE100 PARTS LIST

## CHASSIS ELECTRICAL EQUIPMENT

ITEM NAME	PART NUMBER	QUANTITY
WIRING HARNESS,TAIL L (Ref # 26001)	26001-1007	1
HARNESS,MAIN (Ref # 26001A)	26001-1275	1
FUSE ASSY (Ref # 26004)	26004-1010	1
FUSE,10A,L=30M/M (Ref # 26006)	26006-1002	1
FUSE,15A,L=30M/M (Ref # 26006A)	26006-1003	2
WIRE,LEAD (Ref # 26011)	26011-093	1
YUA BAT 6N6-1D-2 (Ref # 26012)	K26012-034	1
RELAY-TURN SIGNAL (Ref # 27002)	27002-013	1
HORN (Ref # 27003)	27003-1052	1
BAND,SHORT (Ref # 92072)	92072-030	6
BAND,MIDDLE (Ref # 92072A)	92072-031	2
BAND,LONG (Ref # 92072B)	92072-032	3
BAND,WIRING HARNESS (Ref # 92072C)	92072-056	1
DAMPER RUBBER (Ref # 92075)	92075-1044	1
BOLT-UPSET-WS,6X25 (Ref # 180A)	180C0625	2