

## 1984 KE100 PARTS DIAGRAM

CRANKCASE

E1411-0019

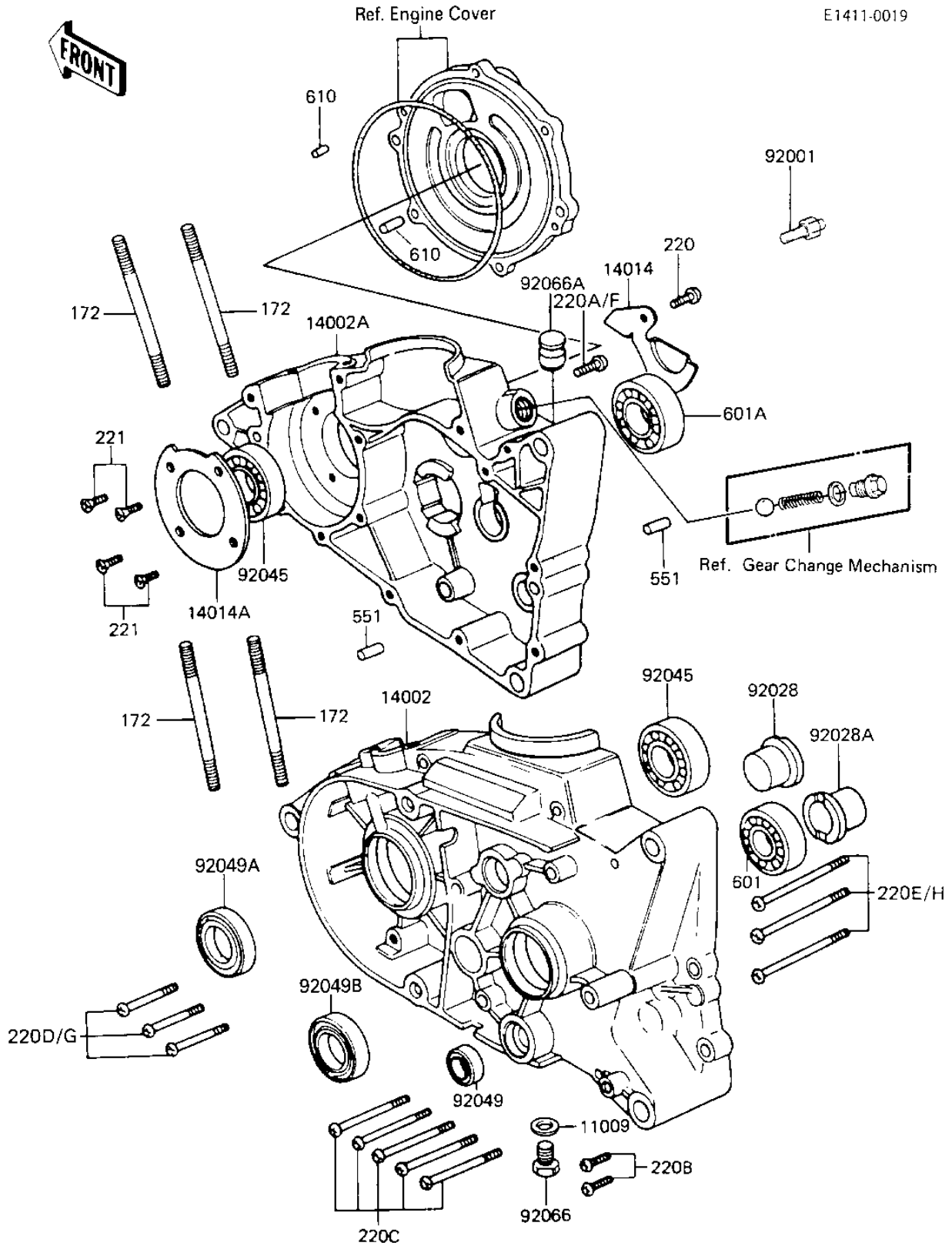

## 1984 KE100 PARTS LIST

### CRANKCASE

ITEM NAME	PART NUMBER	QUANTITY
GASKET CHECK VALVE (Ref # 11009)	92065-058	1
CRANK CASE,RH (Ref # 14002)	14002-1074	1
CRANKCASE,RH (Ref # 14002A)	14002-1210	1
HOLDER BEARING MSSON (Ref # 14014)	14014-008	1
HOLDER CRANKSHAFT BRG (Ref # 14014A)	14014-017	1
BOLT,CRANK BRG HOLDER (Ref # 92001)	92001-1426	1
BUSH OUTPUT SHAFT (Ref # 92028)	92028-025	1
BUSH DRIVE SHAFT (Ref # 92028A)	92028-069	1
BEARING-BALL,#6204 (Ref # 92045)	92045-1032	1
OIL SEAL SB12205 (Ref # 92049)	92049-004	1
SEAL-OIL (Ref # 92049A)	92049-1240	1
OIL SEAL SC25376 (Ref # 92049B)	92050-013	1
PLUG OIL DRAIN (Ref # 92066)	92067-001	1
RUBBER PLUG (Ref # 92066A)	92074-035	1
STUD 8X115 (Ref # 172)	172G08115	1
SCREW PAN HEAD 6X12 (Ref # 220)	220B0612	1
SCREW PAN HEAD 6X25 (Ref # 220B)	220B0625	1
SCREW PAN HEAD 6X40 (Ref # 220C)	220B0640	1
SCREW-PAN-CROS (Ref # 220F)	220X0620	1
SCREW-PAN-CROS (Ref # 220G)	220X0660	1
SCREW-PAN-CROS (Ref # 220H)	220X0665	1
SCREW CNTSNK HD 6X16 (Ref # 221)	221B0616	1
PIN DOWEL 8X16 (Ref # 551)	551A0816	1
BEARING BALL #6004 (Ref # 601)	601B6004	1
BEARING BALL #6005 (Ref # 601A)	601B6005	1
PIN DOWEL 5X12 (Ref # 610)	610A0512	1