

# 1984 KE100 PARTS DIAGRAM

GEAR CHANGE DRUM & FORKS

E1362-0008

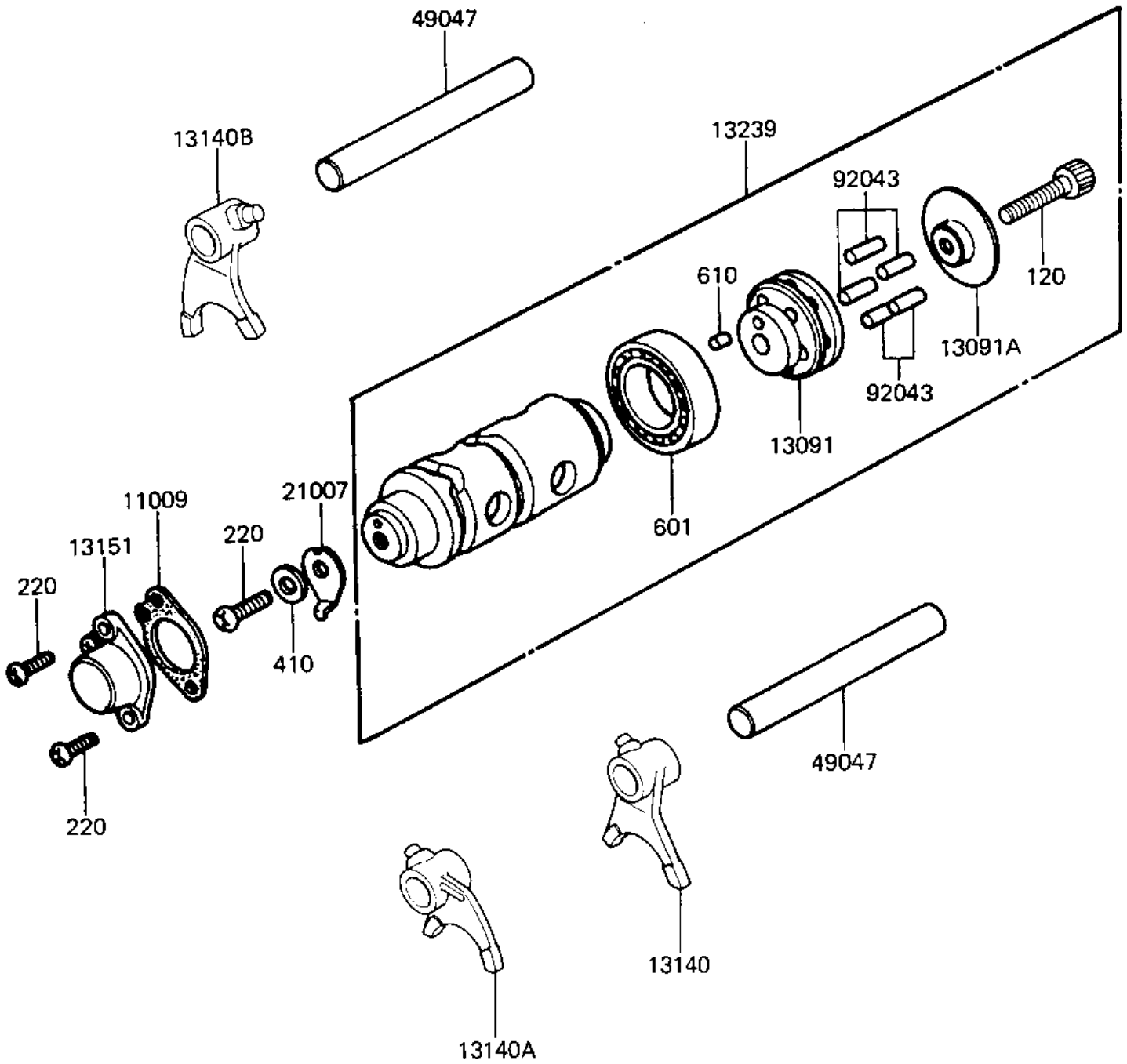

# 1984 KE100 PARTS LIST

## GEAR CHANGE DRUM & FORKS

ITEM NAME	PART NUMBER	QUANTITY
GASKET NEUTRAL SWITCH (Ref # 11009)	13146-002	1
HOLDER (Ref # 13091)	13091-1077	1
HOLDER,CHANGE DRUM (Ref # 13091A)	13142-014	1
SHIFT FORK,LOW&2ND (Ref # 13140)	13140-1026	1
SHIFT FORK,3RD (Ref # 13140A)	13140-1027	1
SHIFT FORK,4TH&TOP (Ref # 13140B)	13140-1028	1
SWITCH,NEUTRAL (Ref # 13151)	13151-1002	1
DRUM ASSY,GEAR CHANGE (Ref # 13239)	13239-1034	1
ROTOR,NEUTRAL INDICTR (Ref # 21007)	21007-1003	1
RODSHIFT,SHORT (Ref # 49047)	13209-014	2
PIN,GEAR CHANGE DRUM (Ref # 92043)	92042-042	5
BOLT-SOCKET, 6X30 (Ref # 120)	120Q0630	1
SCREW PAN HEAD 6X16 (Ref # 220)	220B0616	3
WASHER PLAIN 6MM (Ref # 410)	410B0600	1
BEARING BALL #6004 (Ref # 601)	601B6004	1
PIN-DOWEL,4X6 (Ref # 610)	610A0406	1