

1986 KE100 PARTS DIAGRAM

KICKSTARTER MECHANISM

E1340-0013

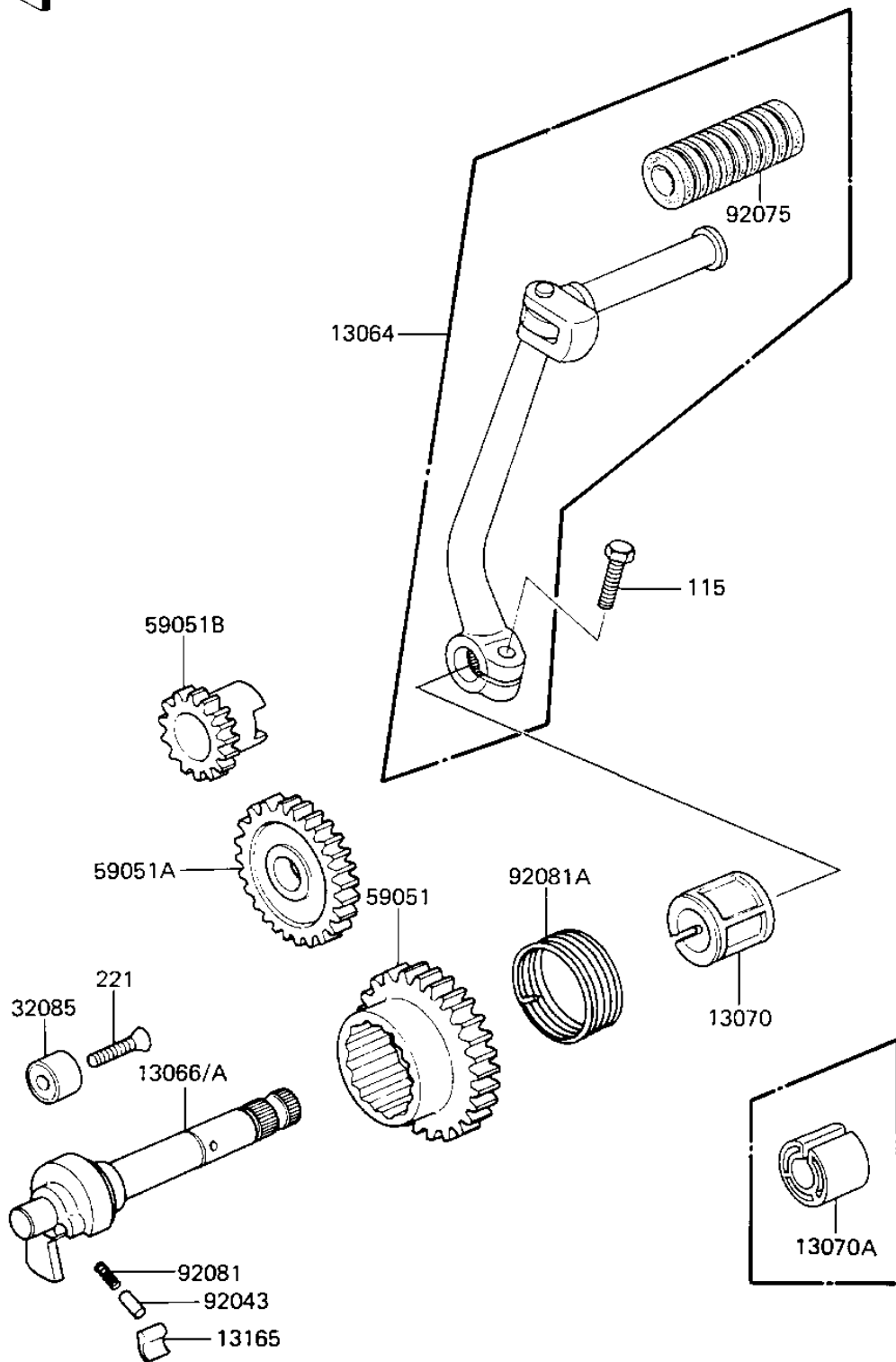

1986 KE100 PARTS LIST

KICKSTARTER MECHANISM

ITEM NAME	PART NUMBER	QUANTITY
LEVER-ASSY-KICK,PEDAL (Ref # 13064)	13064-1039	1
SHAFT-KICK (Ref # 13066A)	13066-1024	1
GUIDE,KICK SPRING (Ref # 13070A)	13070-1130	1
PAWL KICKSTARTER (Ref # 13165)	13069-005	1
STOPPER KICKSTARTER (Ref # 32085)	13072-003	1
GEAR KICKSTARTER (Ref # 59051)	13068-007	1
IDLE GEAR (Ref # 59051A)	13073-004	1
PINION KICKSTARTER (Ref # 59051B)	13075-004	1
P/N,KICKSTARTER PAWL (Ref # 92043)	92043-013	1
RUBBER KICK PEDAL (Ref # 92075)	13063-002	1
SPRING KICK PAWL (Ref # 92081)	92081-014	1
SPRING KICKSTARTER (Ref # 92081A)	92083-004	1
BOLT-SMALL-UPSET (Ref # 115)	115J0825	1
SCREW CNTSNK HD 6X20 (Ref # 221)	221B0620	1