

1968 Bushwhacker PARTS DIAGRAM

IGNITION/GENERATOR/STARTER

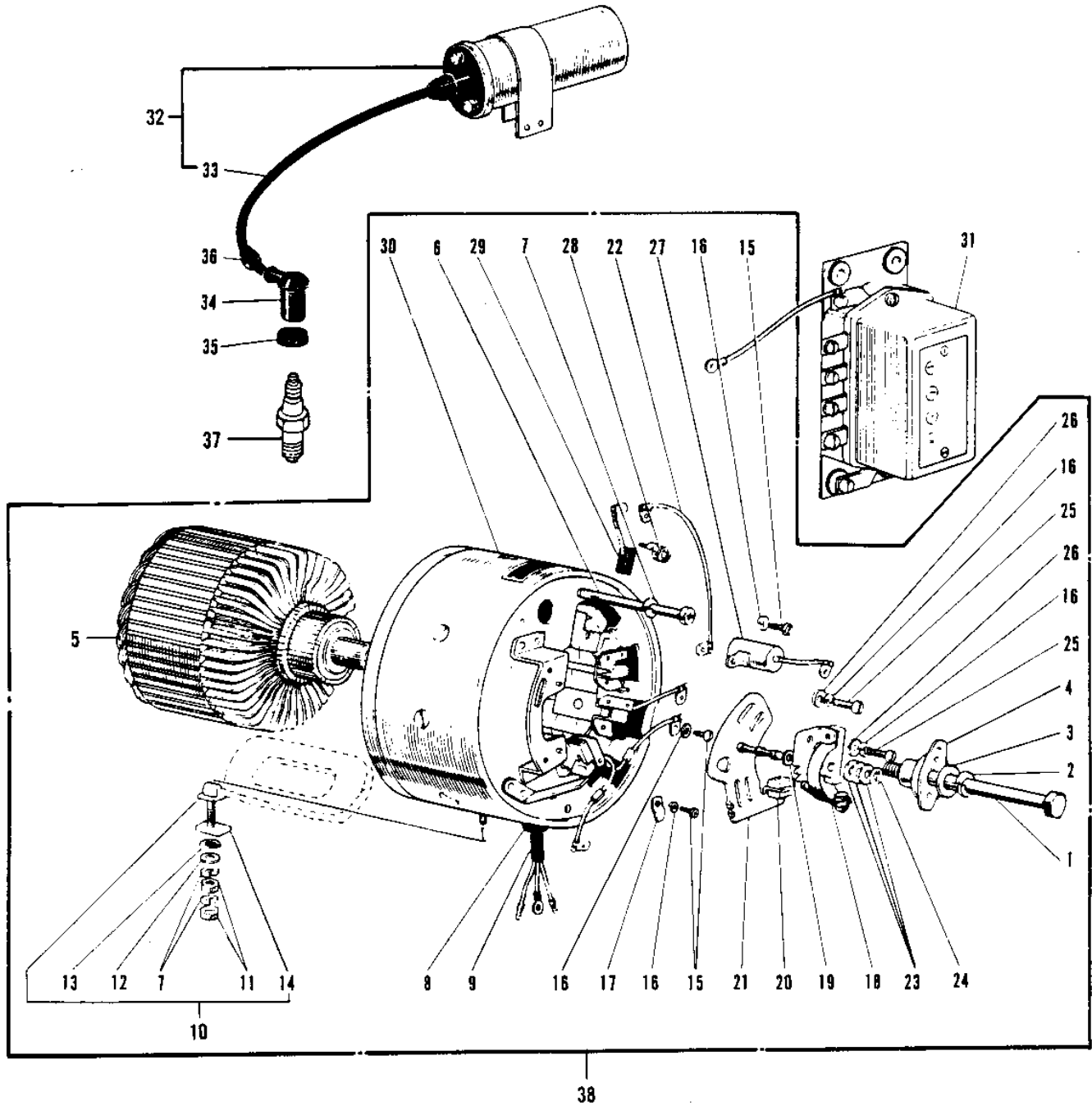

1968 Bushwhacker PARTS LIST

IGNITION/GENERATOR/STARTER

ITEM NAME	PART NUMBER	QUANTITY
BOLT HEX HEAD 8X95 (Ref # 1)	114G0895	
WASHER SPRING 8MM (Ref # 2)	461F0800	
WASHER 8MM (Ref # 3)	21102-003	
CAM CONTACT BREAKER (Ref # 4)	21103-002	
ARMATURE (Ref # 5)	21080-002	
SCREW PAN HEAD 5X88 (Ref # 6)	21099-002	
SCREW PAN HEAD 5X88 (Ref # 6)	92011-019	
WASHER SPRING 5MM (Ref # 7)	461F0500	
UNAVAILABLE IN PRICE BOOK (Ref # 8)	21017-016	
WIRING HARNESS DYNAMO (Ref # 9)	21096-003	
UNAVAILABLE IN PRICE BOOK (Ref # 10)	21090-001	
NUT,5MM (Ref # 11)	311B0500	
WASHER PLAIN 5MM (Ref # 12)	411B0500	
WASHER INSULATOR (Ref # 13)	21092-001	
INSULATOR TERMINAL (Ref # 14)	21091-001	
SCREW PAN HEAD 4X6 (Ref # 15)	220B0406	
WASHER SPRING 4MM (Ref # 16)	461F0400	
CLAMP WIRE (Ref # 17)	21098-003	
ARM CONTACT BREAKER (Ref # 18)	21082-006	
CAM PLATE (Ref # 19)	21106-003	
FELT-OIL (Ref # 20)	21019-011	
PLATE CONTACT BREAKER (Ref # 21)	21084-006	
WIRE LEAD (Ref # 22)	21095-002	
WASHER 0.1MM (Ref # 23)	21108-002	
CIRCLIP 3MM (Ref # 24)	482K3000	
SCREW PAN HEAD 4X8 (Ref # 25)	220B0408	
WASHER PLAIN 4MM (Ref # 26)	410B0400	
CONDENSER (Ref # 27)	21013-012	
SPRING, CARBON BRUSH (Ref # 28)	21089-005	

1968 Bushwhacker PARTS LIST

IGNITION/GENERATOR/STARTER

ITEM NAME	PART NUMBER	QUANTITY
BRUSH CARBON (Ref # 29)	21088-007	
YOKE ASSY (Ref # 30)	21076-002	
REGULATOR,VOLTAGE (Ref # 31)	21066-1003	
COIL IGNITION (Ref # 32)	21121-022	
CORD HIGH TENSION (Ref # 33)	21133-003	
CAP-SPARK PLUG (Ref # 34)	21130-016	
GROMMET PLUG CAP A (Ref # 35)	21131-002	
GROMMET (Ref # 36)	92071-517	
UNAVAILABLE IN PRICE BOOK (Ref # 37)	92070-010A	
SPARK PLUG B8HS (Ref # 37)	B8HS	
DYNAMO STARTER (Ref # 38)	21075-005	