

# 1980 KD80 PARTS DIAGRAM

SIDE COVER/OIL TANK

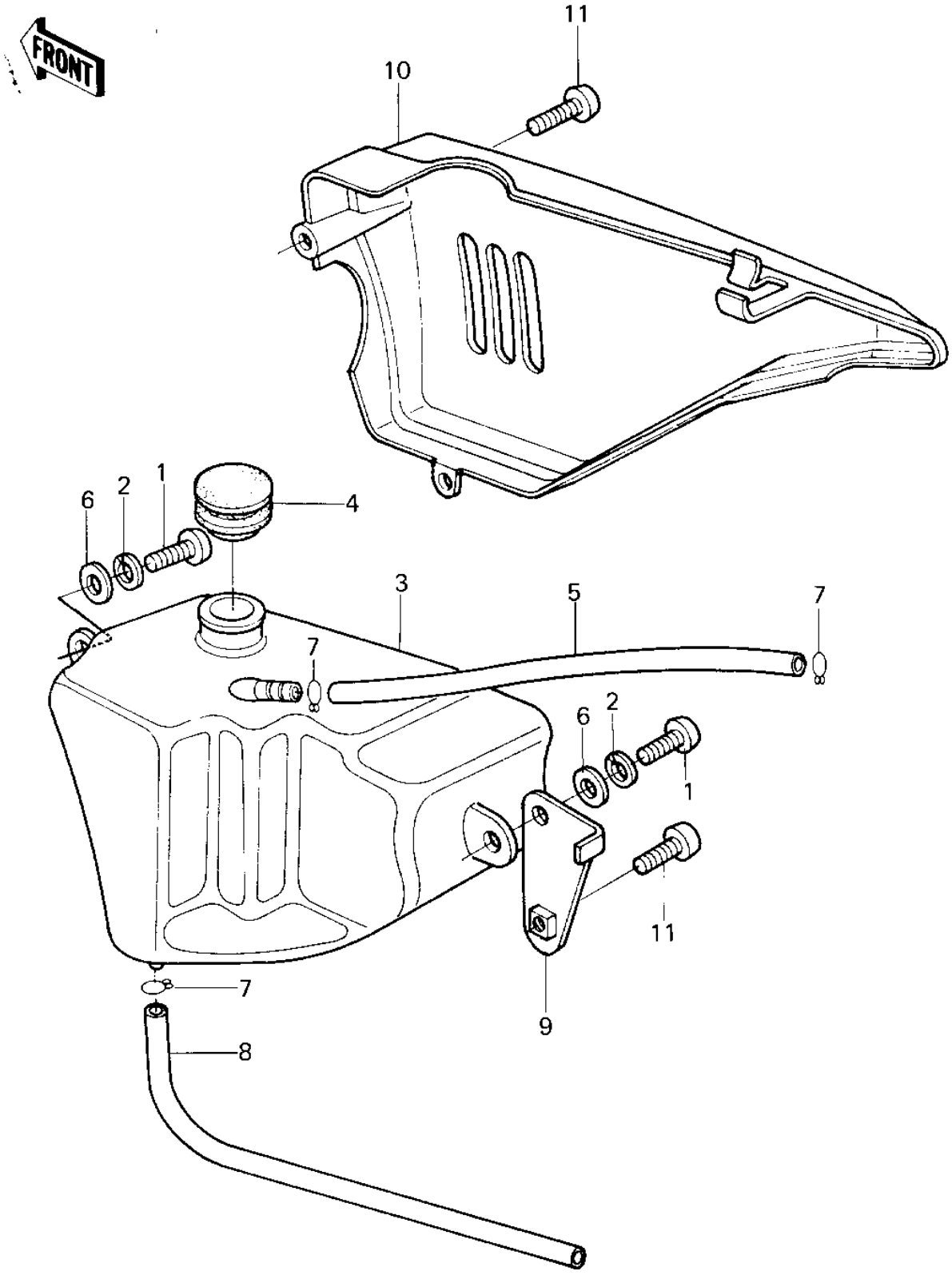

# 1980 KD80 PARTS LIST

## SIDE COVER/OIL TANK

ITEM NAME	PART NUMBER	QUANTITY
SCREW PAN HEAD 6X16 (Ref # 1)	220B0616	3
WASHER SPRING 6MM (Ref # 2)	461F0600	3
TANK,OIL (Ref # 3)	52001-1005	1
CAP,OIL TANK (Ref # 4)	52003-024	1
TUBE-VINYL,5X400 (Ref # 5)	700Q05400	1
WASHER 6.5X20X1.6T (Ref # 6)	92022-125	3
CLAMP FUEL PIPE (Ref # 7)	92037-010	3
TUBE,4.5X9X380 (Ref # 8)	92059-1691	1
BRACKET,R.H.SIDE COVR (Ref # 9)	11034-1621	1
COVER,RH SIDE C ORANG (Ref # 10)	36001-1084-6H	1
COVER,R.H.SIDE,F.RED (Ref # 10)	36001-1084-6L	1
COVER-SIDE,RH,B.BLUE (Ref # 10)	36001-1084-6K	1
SCREW,6X14 (Ref # 11)	92009-1287	2