

1982 KE175 PARTS DIAGRAM

SWING ARM/SHOCK ABSORBERS ('82-'83 KE175)

F2140-0059

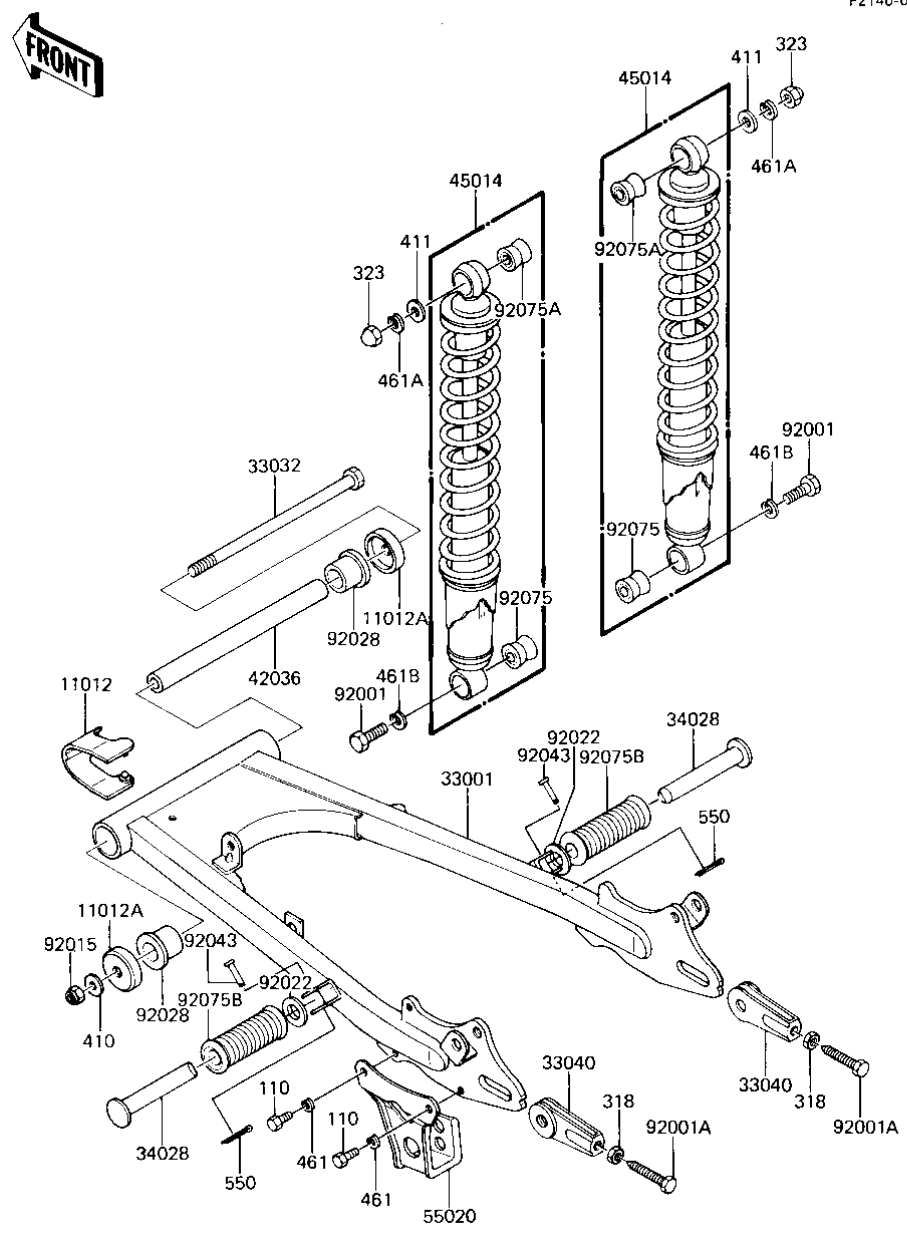

1982 KE175 PARTS LIST

SWING ARM/SHOCK ABSORBERS ('82-'83 KE175)

ITEM NAME	PART NUMBER	QUANTITY
GUARD,CHAIN,FR (Ref # 11012)	55020-1063	1
CAP,SWING ARM (Ref # 11012A)	11012-1036	2
SWING ARM (Ref # 33001)	33001-1061	1
SHAFT,SWING ARM (Ref # 33032)	33032-1005	1
ADJUSTER,CHAIN (Ref # 33040)	33040-1010	2
BAR-RR FOOTREST (OPT) (Ref # 34028)	34028-009	2
SLEEVE,SWING ARM (Ref # 42036)	42036-1019	1
SHOCK ABSBR RR (Ref # 45014)	45014-1137	2
GUARD,CHAIN (Ref # 55020)	55020-1026	1
BOLT,HEX HEAD 10X35 (Ref # 92001)	92001-1252	2
BOLT,8X50 (Ref # 92001A)	92001-1399	2
NUT-LOCK,12MM (Ref # 92015)	92019-009	1
WASHER-PLAIN (OPT) (Ref # 92022)	92022-199	2
BUSH,SWING ARM (Ref # 92028)	92028-1027	2
PIN (Ref # 92043)	92043-1464	2
BUSHING,SHOCK ABSORBE (Ref # 92075)	92075-1216	2
BUSHING,SHOCK ABSORBE (Ref # 92075A)	92075-1217	2
RUBBER,REAR FOOTREST (Ref # 92075B)	92076-024	2
BOLT-UPSET,6X12 (Ref # 110)	112G0612	2
NUT 8MM (Ref # 318)	318B0800	2
NUT,CAP,8M/M (Ref # 323)	323N0800	2
WASHER PLAIN 12MM (Ref # 410)	410B1200	1
WASHER PLAIN 8MM (Ref # 411)	411B0800	2
WASHER SPRING 6MM (Ref # 461)	461F0600	2
WASHER SPRING 8MM (Ref # 461A)	461F0800	2
WASHER SPRING 10MM (Ref # 461B)	461F1000	2
PIN COTTER 2.0X15 (Ref # 550)	550D2015	2