

# 1982 KE175 PARTS DIAGRAM

GENERATOR/REGULATOR

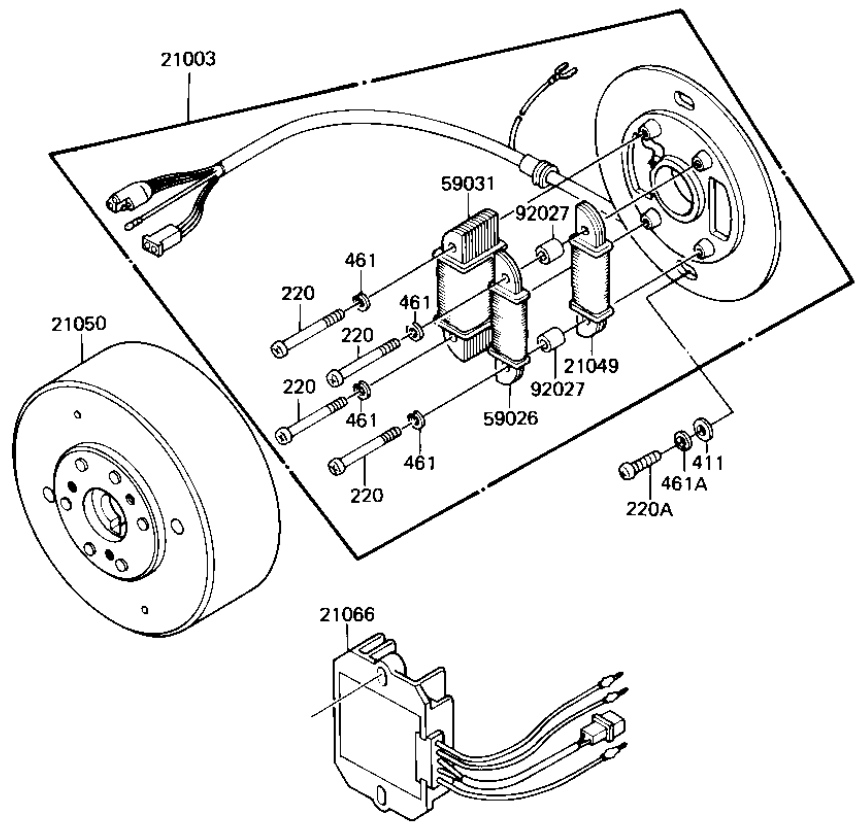

E1810-0032



# 1982 KE175 PARTS LIST

## GENERATOR/REGULATOR

ITEM NAME	PART NUMBER	QUANTITY
STATOR ASSY,MAGNETO (Ref # 21003)	21003-1031	1
COIL,EXITING (Ref # 21049)	21049-1006	1
FLYWHEEL,MAGNETO (Ref # 21050)	21050-1013	1
REGULATOR,VOLTAGE (Ref # 21066)	21066-1012	1
COIL,PULSING (Ref # 59026)	59026-1008	1
COIL,CHARGING (Ref # 59031)	59031-1003	1
COLLAR,COIL (Ref # 92027)	92027-1221	2
SCREW-PAN-CROS (Ref # 220)	220B0540	4
SCREW PAN HEAD 6X20 (Ref # 220A)	220B0620	2
WASHER PLAIN 6MM (Ref # 411)	411B0600	2
WASHER SPRING 5MM (Ref # 461)	461F0500	4
WASHER SPRING 6MM (Ref # 461A)	461F0600	2