

1982 KE175 PARTS DIAGRAM

AIR CLEANER ('82-'83 KE175-D4/D5)

E1130-0004

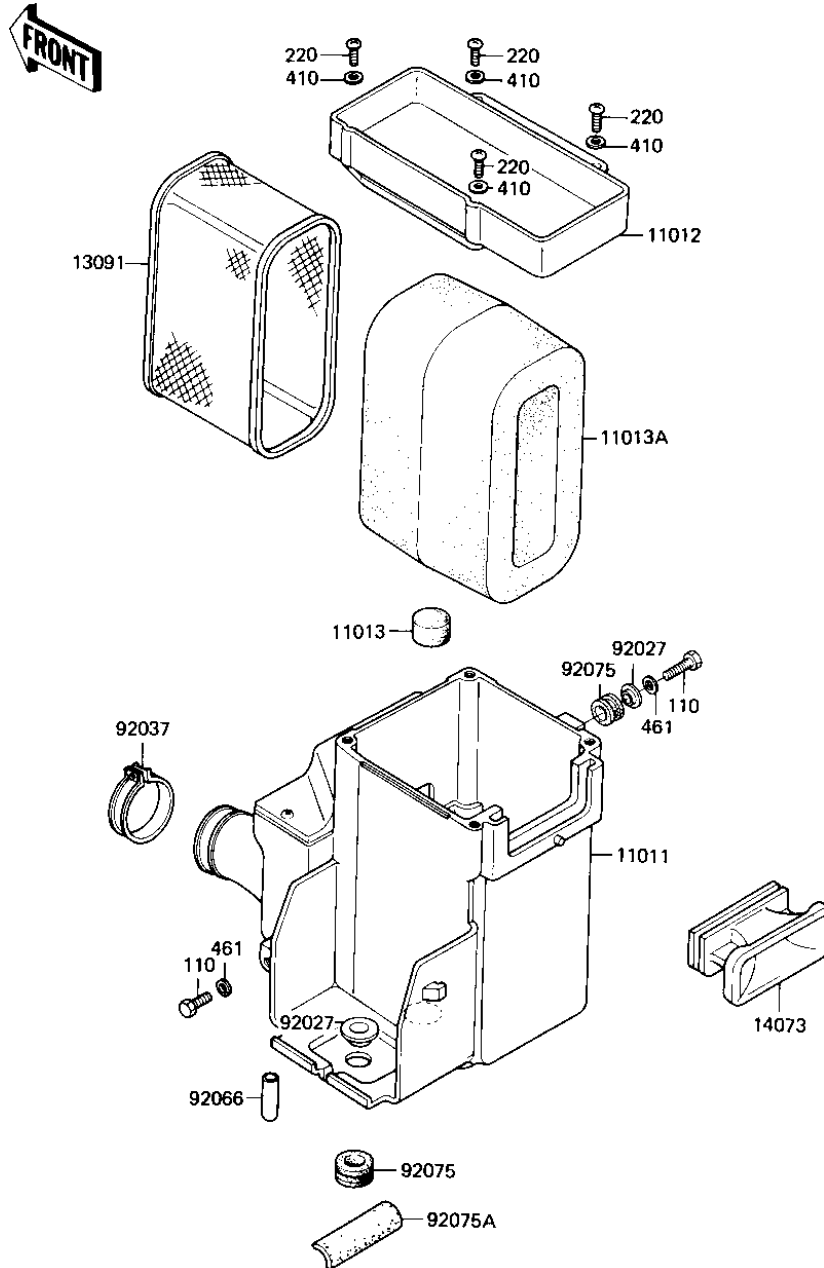

1982 KE175 PARTS LIST

AIR CLEANER ('82-'83 KE175-D4/D5)

ITEM NAME	PART NUMBER	QUANTITY
CASE,AIR CLEANER (Ref # 11011)	11011-1076	1
CAP,AIR CLEANER (Ref # 11012)	11012-1133	1
ELEMENT,AIR CLNR (Ref # 11013)	11013-1019	1
ELEMENT,AIR CLNR (Ref # 11013A)	11013-1042	1
HOLDER,CLENER ELEMENT (Ref # 13091)	11014-011	1
DUCT,AIR CLEANER INLT (Ref # 14073)	14073-1029	1
COLLAR (Ref # 92027)	92027-153	2
CLAMP-INLET PIPE (Ref # 92037)	92037-061	1
PLUG,AIR CLNR DRAIN (Ref # 92066)	92066-1014	1
DAMPER RUBBER (Ref # 92075)	92075-051	2
DAMPER,AIR CLEANER (Ref # 92075A)	92075-1085	1
BOLT-UPSET,6X20 (Ref # 110)	112G0620	2
SCREW-PAN-CROS (Ref # 220)	220B0414	4
WASHER PLAIN 4MM (Ref # 410)	410B0400	4
WASHER SPRING 6MM (Ref # 461)	461F0600	2