

# 1983 KE175 PARTS DIAGRAM

CRANKCASE ('82-'83 KE175-D4/D5)

E1410-0004

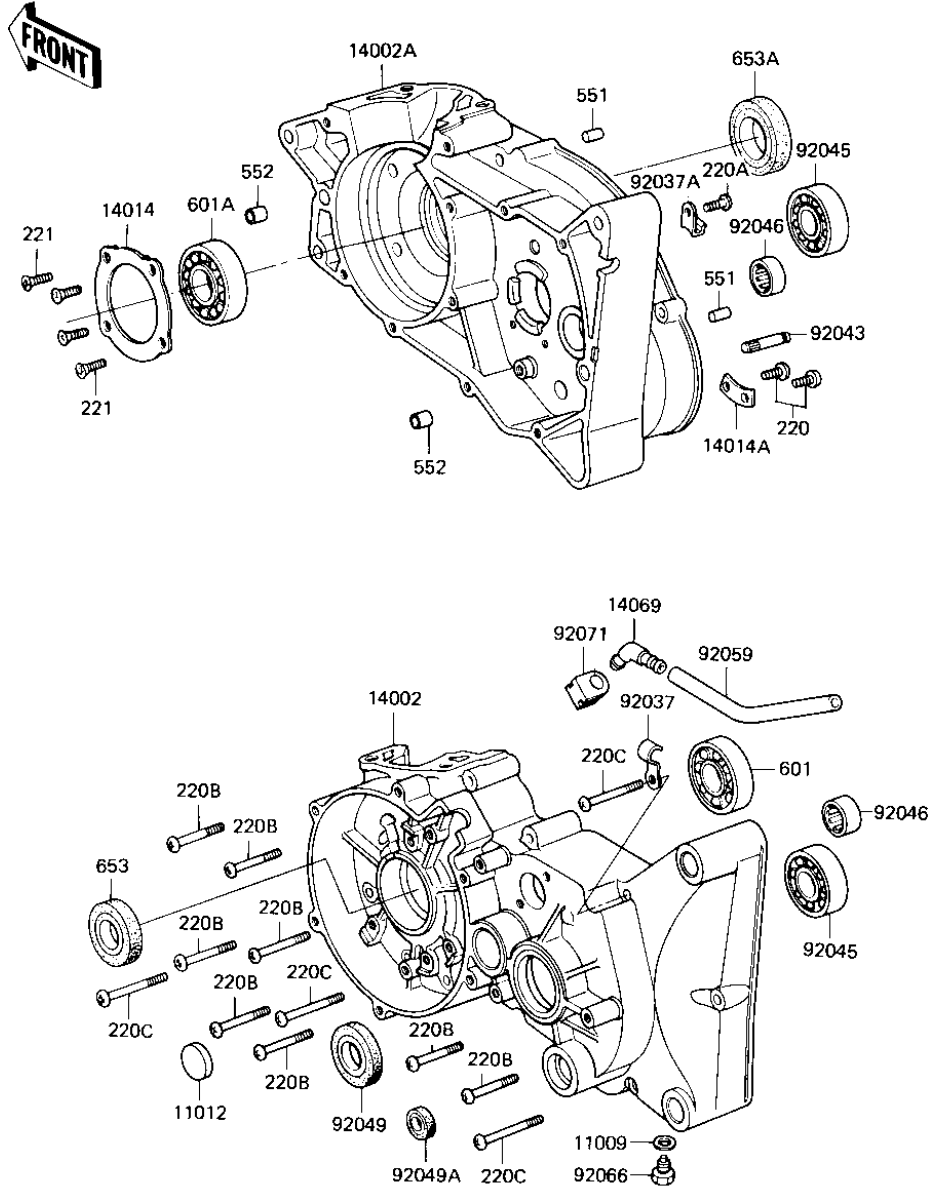

# 1983 KE175 PARTS LIST

CRANKCASE ('82-'83 KE175-D4/D5)

ITEM NAME	PART NUMBER	QUANTITY
GASKET CHECK VALVE (Ref # 11009)	92065-058	1
CAP,DRIVE SHAFT SEAL (Ref # 11012)	11012-1040	1
CRANKCASE,L.H,F.BLACK (Ref # 14002)	14002-1023	1
CRANKCASE,R.H,F.BLACK (Ref # 14002A)	14002-1079	1
HOLDER-CRANK BEARING (Ref # 14014)	14014-021	1
HOLDER-MISSION BERNG (Ref # 14014A)	14014-022	1
BREATHER ASSY (Ref # 14069)	14069-1001	1
CLAMP CABLE (Ref # 92037)	92037-016	1
CLAMP,OIL PIPE (Ref # 92037A)	92037-157	1
PIN,KICK SPRING (Ref # 92043)	92043-117	1
BEARING-BALL,6204C3 (Ref # 92045)	92045-1046	2
BEARING-NEEDLE (Ref # 92046)	92046-026	2
OIL SEAL SC30426 (Ref # 92049)	92050-039	1
OIL SEAL,TB13225.5 (Ref # 92049A)	92051-005	1
PIPE-BREATHER (Ref # 92059)	92059-061	1
PLUG OIL DRAIN (Ref # 92066)	92067-001	1
GROMMET (Ref # 92071)	92071-042	1
SCREW PAN HEAD 6X12 (Ref # 220)	220B0612	2
SCREW PAN HEAD 6X14 (Ref # 220A)	220B0614	1
SCREW PAN HEAD 6X40 (Ref # 220B)	220B0640	8
SCREW PAN HEAD 6X60 (Ref # 220C)	220B0660	4
SCREW CNTSNK HD 6X16 (Ref # 221)	221B0616	4
PIN DOWEL 8X16 (Ref # 551)	551A0816	2
PIN,DOWEL,6.5X10X12 (Ref # 552)	552B1012	2
BEARING BALL #6205 (Ref # 601)	601B6205	1
BEARING BALL #6305 (Ref # 601A)	601B6305	1
SEAL-OIL (Ref # 653)	92049-1250	1
OIL SEAL TB32457 (Ref # 653A)	653B324507	1