

1982 KE175 PARTS DIAGRAM

CRANKSHAFT/PISTON ('82-'83 KE175-D4/D5)

E1320-0011

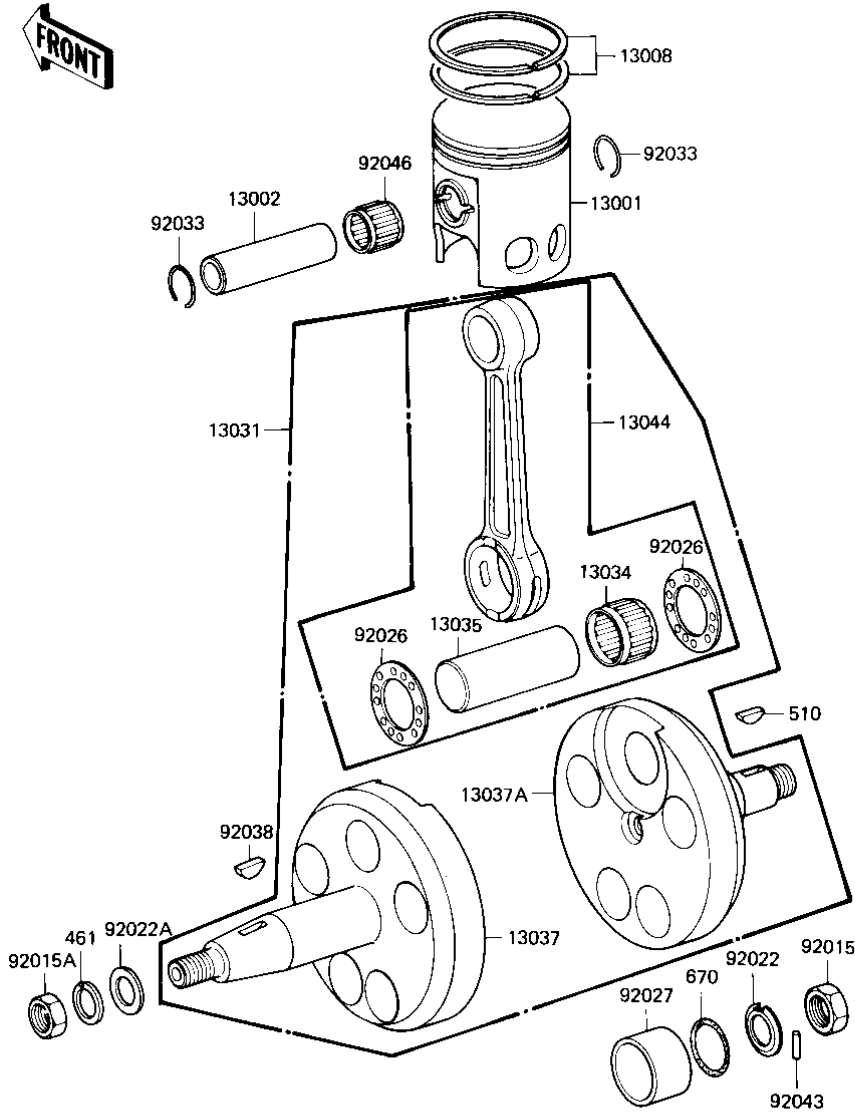

1982 KE175 PARTS LIST

CRANKSHAFT/PISTON ('82-'83 KE175-D4/D5)

ITEM NAME	PART NUMBER	QUANTITY
PISTON,STD (Ref # 13001)	13001-1041	1
PIN-PISTON (Ref # 13002)	13002-1004	1
RING SET,STD (Ref # 13008)	13008-5024	1
CRANKSHAFT ASSY (Ref # 13031)	13031-1011	1
BEARING,BIG END (Ref # 13034)	13034-042	1
CRANK PIN (Ref # 13035)	13035-022	1
CRANKSHAFT,L.H. (Ref # 13037)	13037-1012	1
CRANKSHAFT,R.H. (Ref # 13037A)	13037-1013	1
CONNECTING ROD ASSY, (Ref # 13044)	13044-5012	1
NUT 18MM (Ref # 92015)	92015-019	1
NUT 14MM (Ref # 92015A)	92015-043	1
WASHER,LOCK,18MM (Ref # 92022)	92022-1231	1
WASHER-PLAIN,14MM (Ref # 92022A)	92022-172	1
WASHER SIDE (Ref # 92026)	92026-011	2
COLLAR,25X32X10.5 (Ref # 92027)	92143-1370	1
CIRCLIP PISTON PIN (Ref # 92033)	92036-004	2
WOODRUFF KEY (Ref # 92038)	92038-001	1
PIN,DOWEL,2.5X14.8 (Ref # 92043)	92042-051	1
BEARING-NEEDLE (Ref # 92046)	92046-1038	1
WASHER SPRING 14MM (Ref # 461)	461F1400	1
KEY,WOODRUFF (Ref # 510)	510A4200	1
"O" RING,20MM (Ref # 670)	670B2020	1