

1980 KE175 PARTS DIAGRAM

HEADLIGHT ('80-'81 KE175-D2/D3)

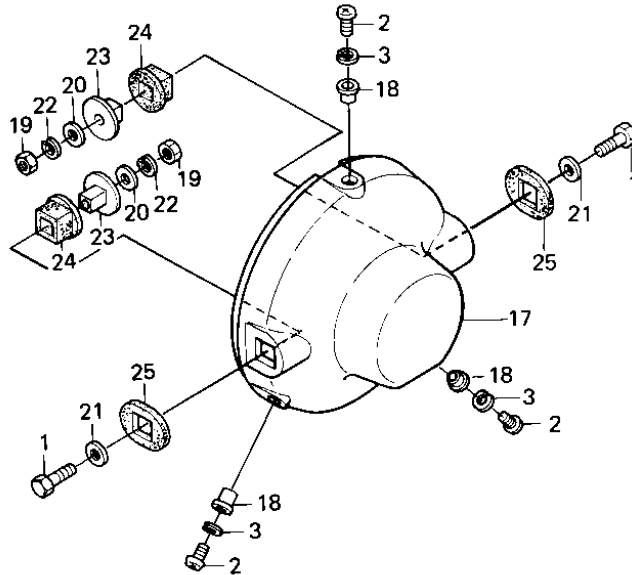
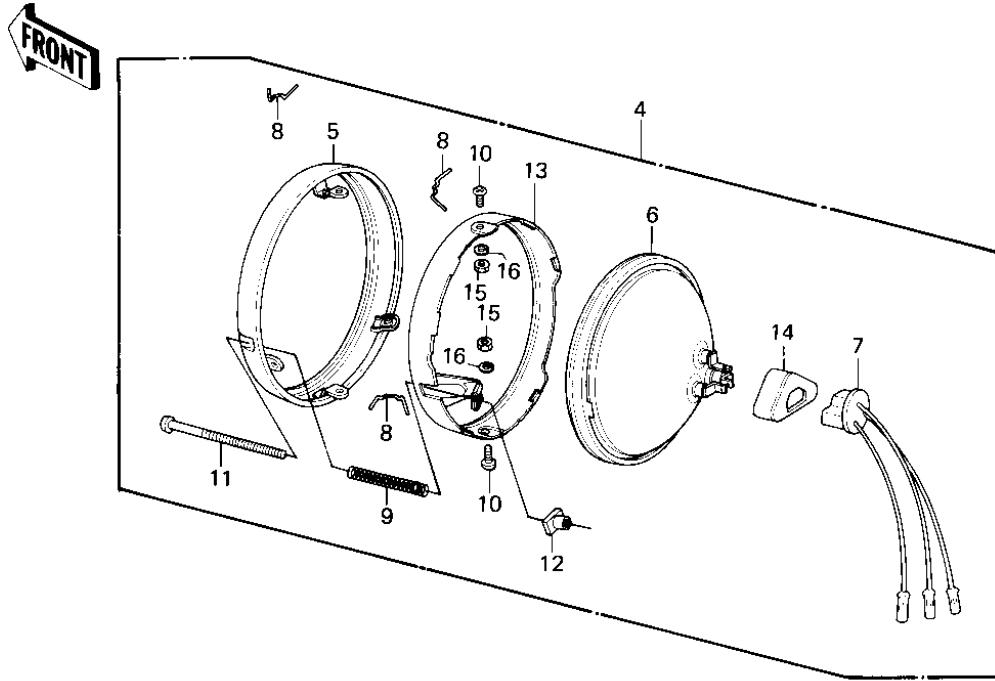

1980 KE175 PARTS LIST

HEADLIGHT ('80-'81 KE175-D2/D3)

ITEM NAME	PART NUMBER	QUANTITY
BOLT-SMALL,8X32 (Ref # 1)	114N0832	2
SCREW PAN HEAD 5X12 (Ref # 2)	220B0512	3
WASHER SPRING 5MM (Ref # 3)	461F0500	3
LAMP UNIT,HEAD (Ref # 4)	23004-1018	1
RIM,HEAD LAMP (Ref # 5)	23006-1004	1
SEALED BEAM UNIT (Ref # 6)	23007-073	1
SOCKET ASSY,HD LIGHT (Ref # 7)	23008-044	1
CLAMP,HEAD LAMP LENS (Ref # 8)	23009-015	3
SPRING,FOCUS ADJUST (Ref # 9)	23014-012	1
SCREW,LENS FITTING (Ref # 10)	23019-026	2
SCREW,FOCUS ADJUST (Ref # 11)	23019-027	1
NUT ADJUST (Ref # 12)	23020-012	1
RETAINER,SEALED BEAM (Ref # 13)	23072-002	1
COVER,HD LAMP SOCKET (Ref # 14)	23081-001	1
NUT,4MM (Ref # 15)	311B0400	2
WASHER SPRING 5MM (Ref # 16)	461F0500	2
BODY,HEAD LAMP,BLACK (Ref # 17)	23005-1007-6Z	1
WASHER (Ref # 18)	23021-010	3
NUT,8M/M (Ref # 19)	317B0800	2
WASHER PLAIN 8MM (Ref # 20)	411B0800	2
WASHER,PLAIN,8MM (Ref # 21)	411D0800	2
WASHER SPRING 8MM (Ref # 22)	461F0800	2
COLLAR,HEAD LAMP (Ref # 23)	92027-1105	2
DAMPER RUBBER,HD LAMP (Ref # 24)	92075-1077	2
DAMPER RUBBER,HD LAMP (Ref # 25)	92075-1078	2