

1980 KE175 PARTS DIAGRAM

SIDE COVERS/CHAIN COVER ('80-'81 KE175-D)

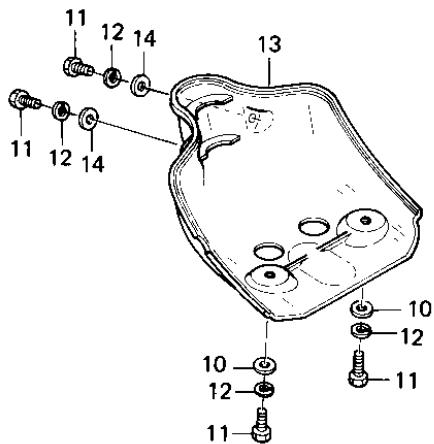
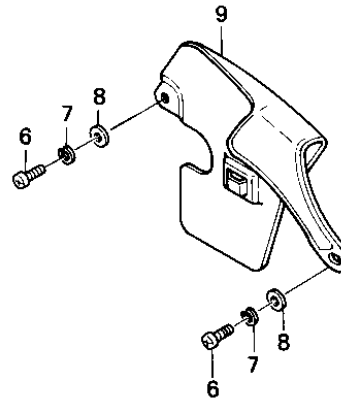
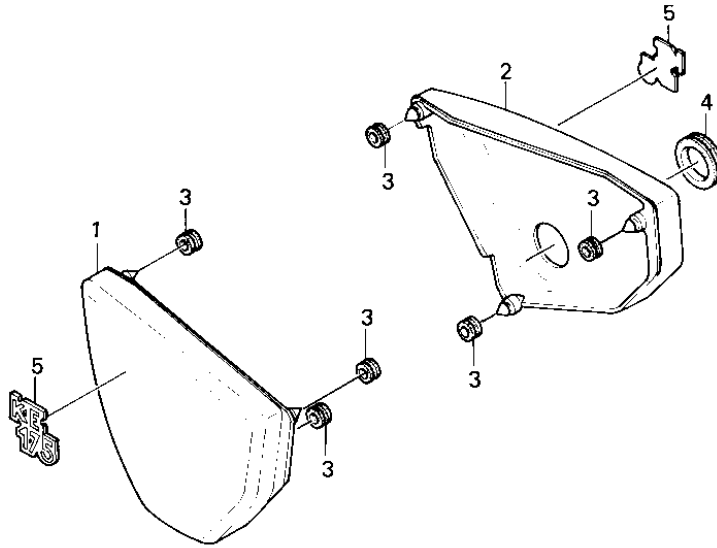

1980 KE175 PARTS LIST

SIDE COVERS/CHAIN COVER ('80-'81 KE175-D)

ITEM NAME	PART NUMBER	QUANTITY
COVER,SIDE,L.H,F.RED (Ref # 1)	36001-1026-6L	1
COVER,SIDE,LH,B.BLUE (Ref # 1)	36001-1026-6K	1
COVER-SIDE,LH,S.B.YLW (Ref # 1)	36001-1026-6G	1
COVER SIDE R.H FIRECRACKER RED (Ref # 2)	36001-1031-6L	1
COVER,SIDE,RH,B.BLUE (Ref # 2)	36001-1031-6K	1
COVER-SIDE,RH,S.B.YLW (Ref # 2)	36001-1031-6G	1
GROMMET (Ref # 3)	92071-056	6
GROMMET,L.H SIDE COV (Ref # 4)	92071-080	1
MARK,SIDE COVER (Ref # 5)	56018-1035	2
SCREW PAN HEAD 6X16 (Ref # 6)	220B0616	2
WASHER SPRING 6MM (Ref # 7)	461F0600	2
WASHER PLAIN 6MM (Ref # 8)	411B0600	2
CASE-CHAIN (Ref # 9)	36014-1007	1
WASHER-PLAIN,7MM (Ref # 10)	92022-240	4
BOLT-UPSET,6X16 (Ref # 11)	112G0616	4
WASHER SPRING 6MM (Ref # 12)	461F0600	4
GUARD,ENGINE (Ref # 13)	55020-1025	1