

# 1980 KE175 PARTS DIAGRAM

MUFFLER ('80-'81 KE175-D2/D3)

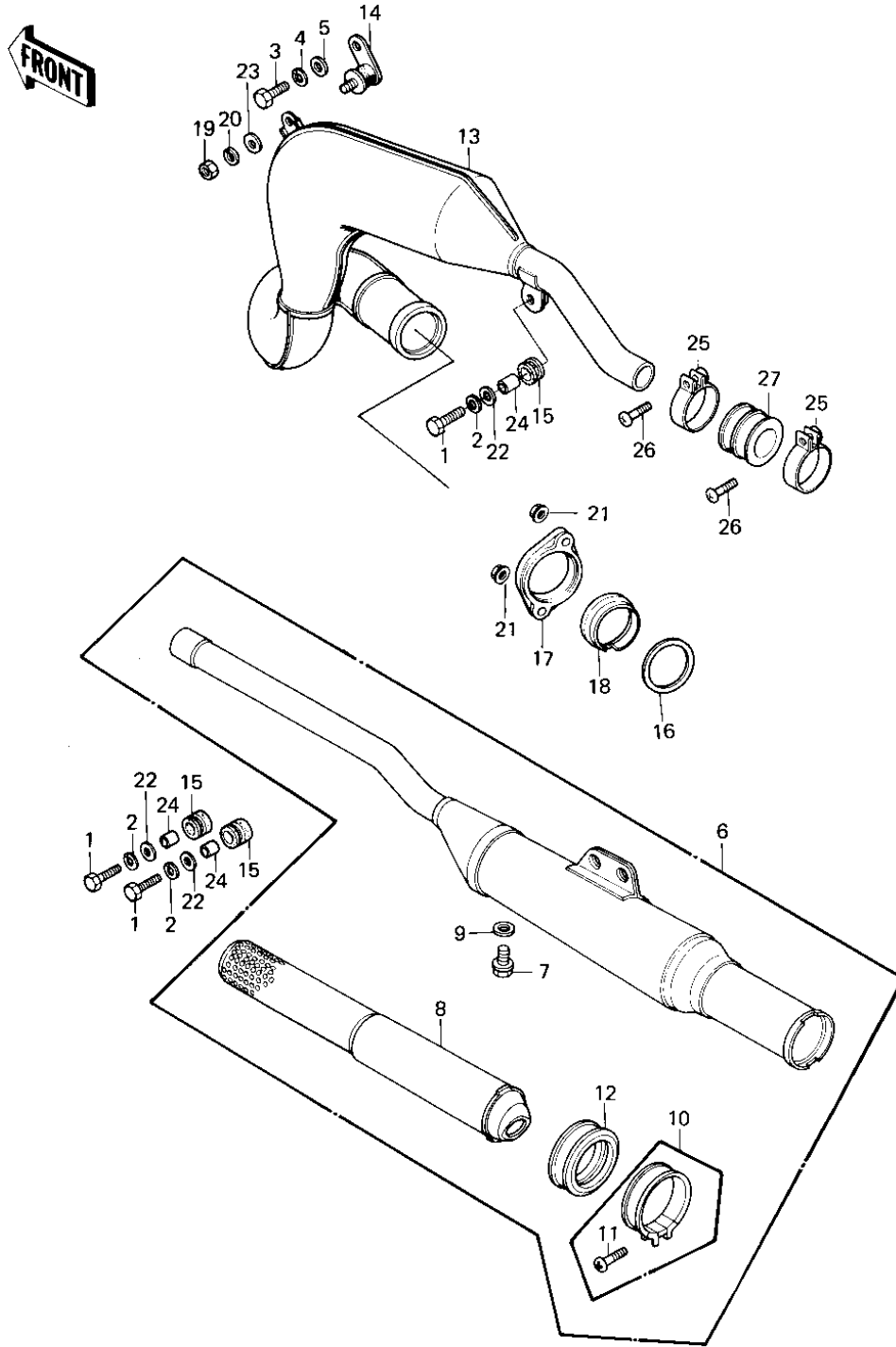

# 1980 KE175 PARTS LIST

MUFFLER ('80-'81 KE175-D2/D3)

ITEM NAME	PART NUMBER	QUANTITY
BOLT HEX HEAD 8X28 (Ref # 1)	114G0828	3
WASHER SPRING 8MM (Ref # 2)	461F0800	3
BOLT-SMALL-UPSET,8X16 (Ref # 3)	115G0816	1
WASHER SPRING 8MM (Ref # 4)	461F0800	1
WASHER PLAIN 8MM (Ref # 5)	410B0800	1
MUFFLER ASSY (Ref # 6)	18001-1153	1
BOLT HEX HEAD 6X8 (Ref # 7)	110B0608	1
BAFFLE PIPE,MUFFLER (Ref # 8)	49099-1006	1
WASHER OIL PUMP BANJO (Ref # 9)	92022-077	1
CLAMP (Ref # 10)	92037-171	1
SCREW-PAN-CROS (Ref # 11)	220B0535	1
DUST SHIELD,MUFFLER (Ref # 12)	92093-1013	1
BODY,MUFFLER (Ref # 13)	18006-1050	1
BRACKET,MUFFLER (Ref # 14)	18061-060	1
DAMPER RUBBER-MUFFLER (Ref # 15)	18063-005	3
GASKET EXHAUST PIPE (Ref # 16)	18067-008	1
HOLDER,EXHAUST (Ref # 17)	18069-049	1
INSERT,EXHAUST HOLDER (Ref # 18)	18070-007	1
NUT,8M/M (Ref # 19)	317B0800	1
WASHER SPRING 8MM (Ref # 20)	461F0800	1
NUT,8M/M (Ref # 21)	92015-1014	2
WASHER,8X26X2.3 (Ref # 22)	92022-1564	3
WASHER,8.5X20X1.6 (Ref # 23)	92022-1561	1
COLLAR (Ref # 24)	92027-102	3
CLAMP,CARBURETOR HOLD (Ref # 25)	92037-1242	2
SCREW-PAN-CROS,6X35,B (Ref # 26)	220C0635	2
SEAL,EXHAUST PIPE (Ref # 27)	92093-1012	1