

1981 KE175 PARTS DIAGRAM

AIR CLEANER ('80-'81 KE175-D2/D3)

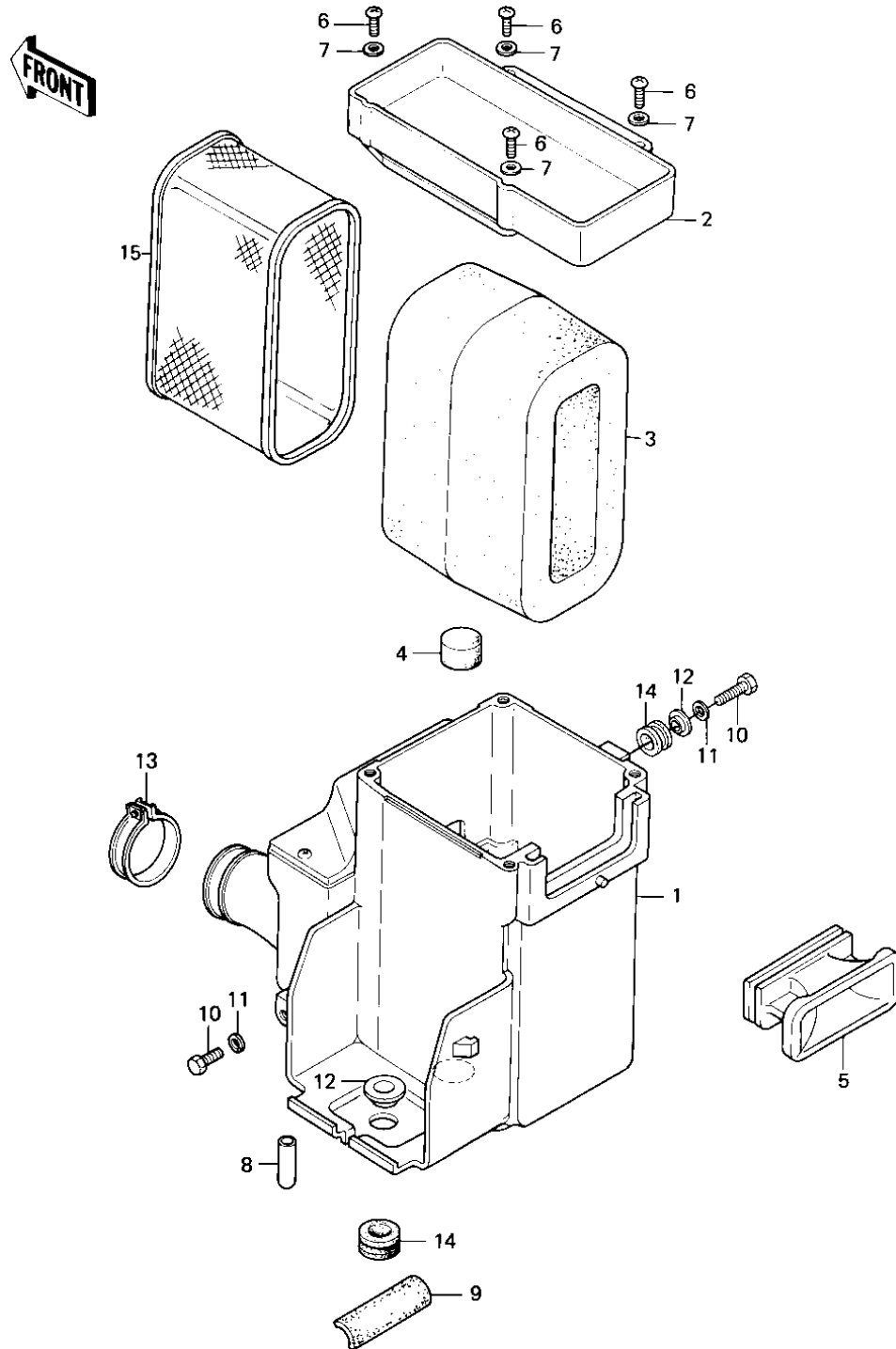

1981 KE175 PARTS LIST

AIR CLEANER ('80-'81 KE175-D2/D3)

ITEM NAME	PART NUMBER	QUANTITY
CASE,AIR CLEANER (Ref # 1)	11011-1076	1
CAP,AIR CLEANER (Ref # 2)	11012-1133	1
ELEMENT,AIR CLNR (Ref # 3)	11013-1042	1
ELEMENT,AIR CLNR (Ref # 4)	11013-1019	1
DUCT,AIR CLEANER INLT (Ref # 5)	14073-1029	1
SCREW-PAN-CROS (Ref # 6)	220B0414	1
WASHER PLAIN 4MM (Ref # 7)	410B0400	1
PLUG,AIR CLNR DRAIN (Ref # 8)	92066-1014	1
DAMPER,AIR CLEANER (Ref # 9)	92075-1085	1
BOLT-UPSET,6X20 (Ref # 10)	112G0620	1
WASHER SPRING 6MM (Ref # 11)	461F0600	1
COLLAR (Ref # 12)	92027-153	1
CLAMP-INLET PIPE (Ref # 13)	92037-061	1
DAMPER RUBBER (Ref # 14)	92075-051	1
HOLDER,CLENER ELEMENT (Ref # 15)	11014-011	1