

1981 KE175 PARTS DIAGRAM

CRANKCASE ('80-'81 KE175-D2/D3)

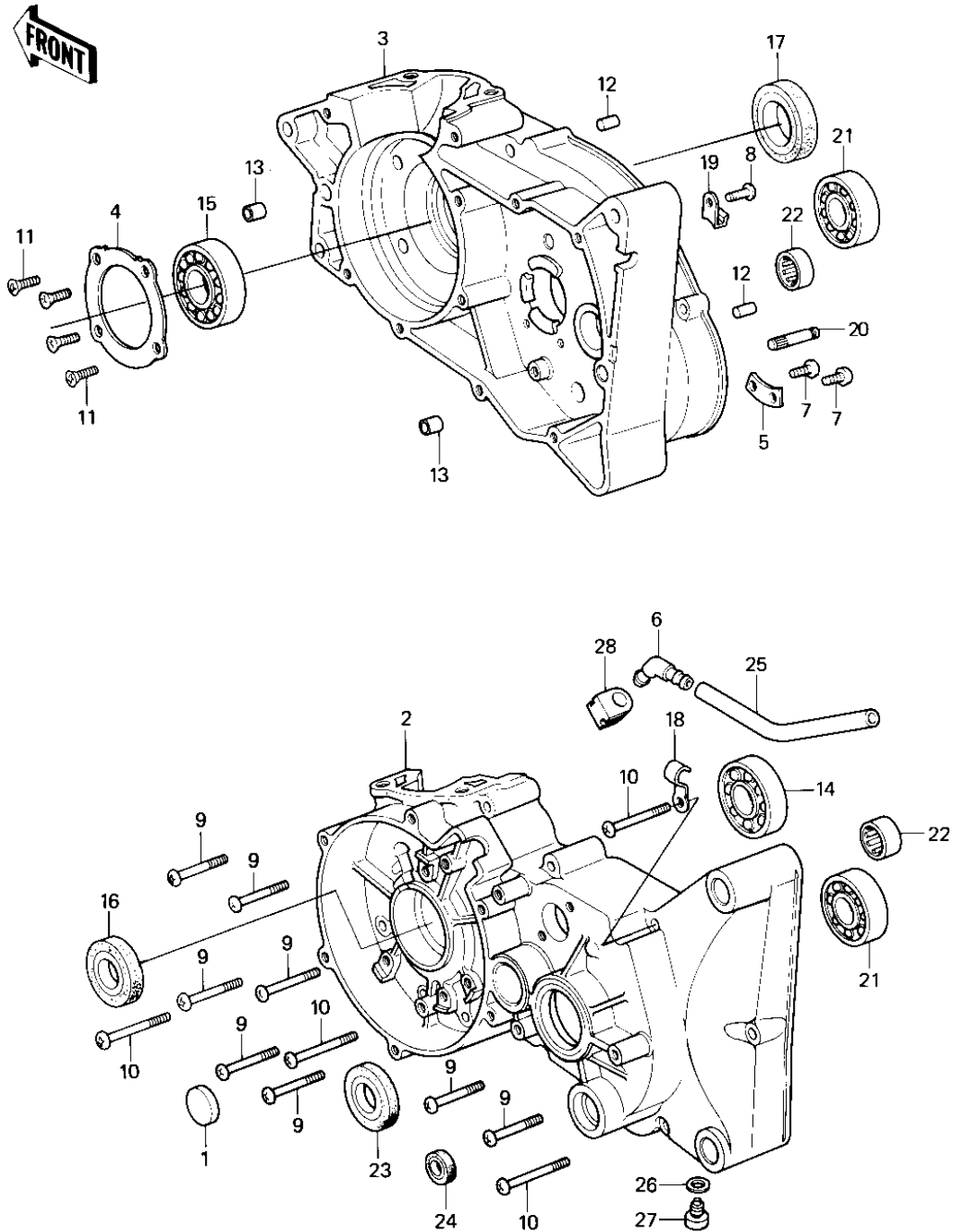

1981 KE175 PARTS LIST

CRANKCASE ('80-'81 KE175-D2/D3)

ITEM NAME	PART NUMBER	QUANTITY
CAP,DRIVE SHAFT SEAL (Ref # 1)	11012-1040	1
CRANKCASE,L.H,F.BLACK (Ref # 2)	14002-1023	1
CRANKCASE,R.H,F.BLACK (Ref # 3)	14002-1079	1
HOLDER-CRANK BEARING (Ref # 4)	14014-021	1
HOLDER-MISSION BERNG (Ref # 5)	14014-022	1
BREATHER ASSY (Ref # 6)	14069-1001	1
SCREW PAN HEAD 6X12 (Ref # 7)	220B0612	1
SCREW PAN HEAD 6X14 (Ref # 8)	220B0614	1
SCREW PAN HEAD 6X40 (Ref # 9)	220B0640	1
SCREW PAN HEAD 6X60 (Ref # 10)	220B0660	1
SCREW CNTSNK HD 6X16 (Ref # 11)	221B0616	1
PIN DOWEL 8X16 (Ref # 12)	551A0816	1
PIN,DOWEL,6.5X10X12 (Ref # 13)	552B1012	1
BEARING BALL #6205 (Ref # 14)	601B6205	1
BEARING BALL #6305 (Ref # 15)	601B6305	1
SEAL-OIL (Ref # 16)	92049-1250	1
OIL SEAL TB32457 (Ref # 17)	653B324507	1
CLAMP CABLE (Ref # 18)	92037-016	1
CLAMP,OIL PIPE (Ref # 19)	92037-157	1
PIN,KICK SPRING (Ref # 20)	92043-117	1
BEARING-BALL,6204C3 (Ref # 21)	92045-1046	1
BEARING-NEEDLE (Ref # 22)	92046-026	1
OIL SEAL SC30426 (Ref # 23)	92050-039	1
OIL SEAL,TB13225.5 (Ref # 24)	92051-005	1
PIPE-BREATHER (Ref # 25)	92059-061	1
GASKET CHECK VALVE (Ref # 26)	92065-058	1
PLUG OIL DRAIN (Ref # 27)	92067-001	1
GROMMET (Ref # 28)	92071-042	1