

1968 Roadrunner PARTS DIAGRAM FRAME/FRAME FITTINGS

R
1

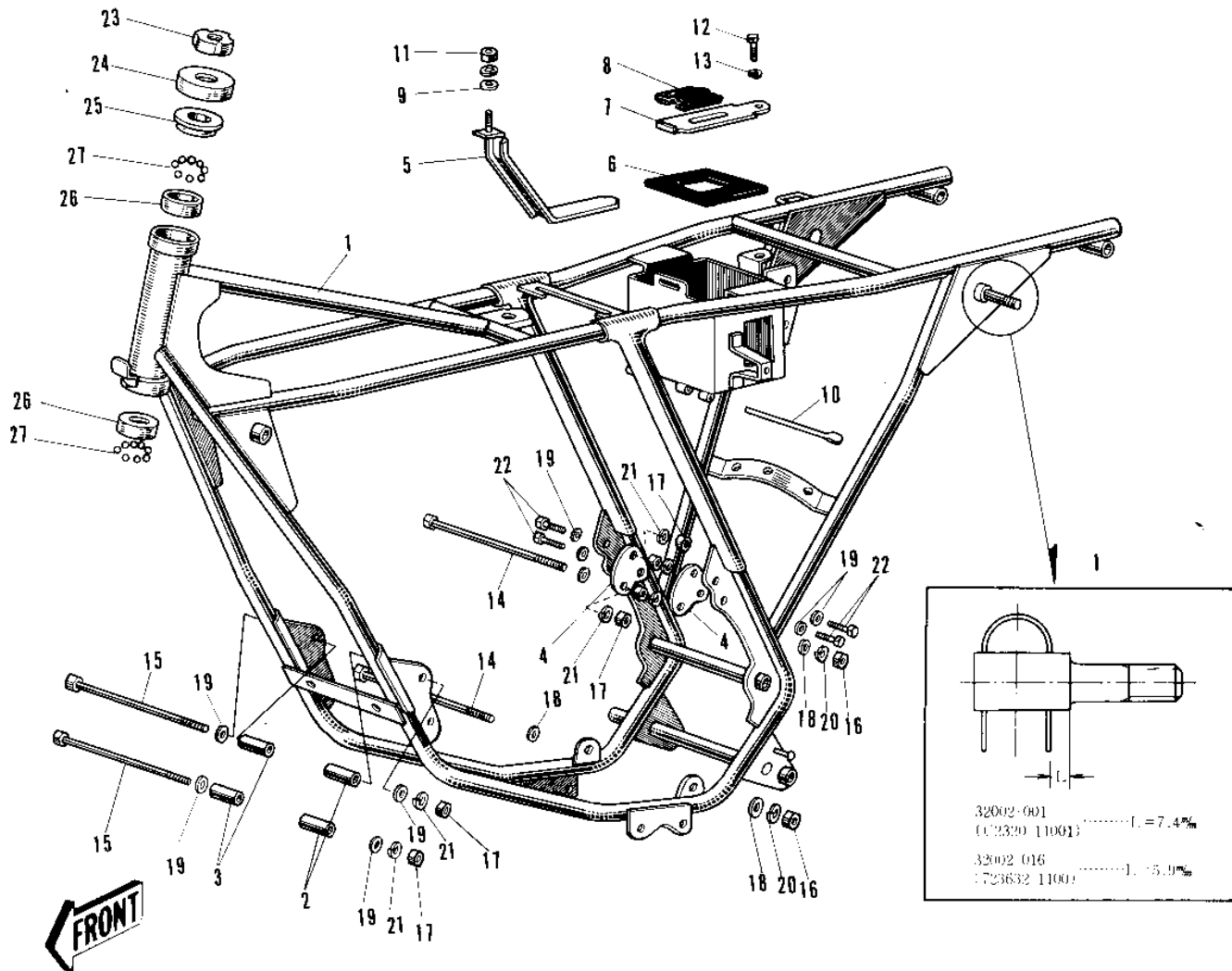

1968 Roadrunner PARTS LIST

FRAME/FRAME FITTINGS

ITEM NAME	PART NUMBER	QUANTITY
FRAME (Ref # 1)	32002-001	1
UNAVAILABLE IN PRICE BOOK (Ref # 1)	32002-016	1
COLLAR ENG MOUNT A (Ref # 2)	92027-048	1
COLLAR ENG MOUNT B (Ref # 3)	92027-020	1
WASHER-LOCK,16MM (Ref # 4)	92030-001	1
BAND OIL TANK (Ref # 5)	32100-006	1
MAT BATTERY (Ref # 6)	32103-001	1
PLATE BATTERY (Ref # 7)	32100-001	1
PROTECTOR BATTERY (Ref # 8)	31082-002	1
WASHER PLAIN 6MM (Ref # 9)	410B0600	1
PIN (Ref # 10)	32111-001	1
NUT 6MM (Ref # 11)	311B0600	1
SCREW PAN HEAD 6X12 (Ref # 12)	220B0612	1
WASHER SPRING 6MM (Ref # 13)	461F0600	1
BOLT, FLANGED, 10X110 (Ref # 14)	92001-1602	1
BOLT HEX HEAD 8X100 (Ref # 15)	110B08100	1
NUT,10MM (Ref # 16)	314B1000	1
NUT,8MM (Ref # 17)	311B0800	1
WASHER PLAIN 10MM (Ref # 18)	410B1000	1
WASHER PLAIN 8MM (Ref # 19)	410B0800	1
WASHER SPRING 10MM (Ref # 20)	461F1000	1
WASHER SPRING 8MM (Ref # 21)	461F0800	1
BOLT-SMALL-UPSET,8X16 (Ref # 22)	115G0816	1
NUT STEERING STEM LCK (Ref # 23)	92090-006	1
CAP STEERING STEM (Ref # 24)	46098-004	1
CONE UPPER BEARING (Ref # 25)	92047-005	1
RACE BEARING (Ref # 26)	92048-004	1
BALL STEEL 3/16' (Ref # 27)	600A0600	1