

1969 Roadrunner PARTS DIAGRAM

OIL PUMP

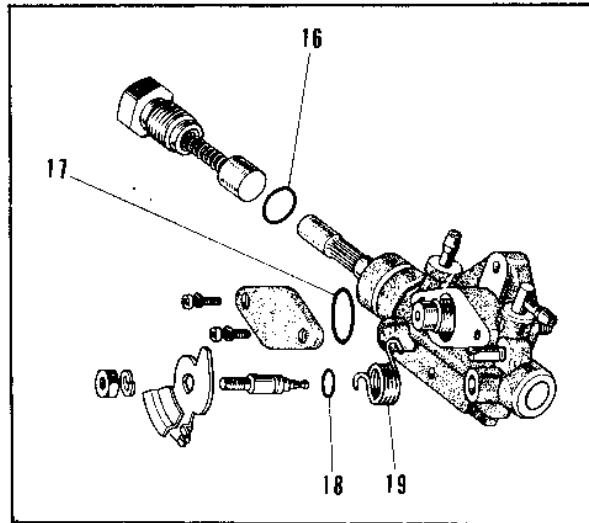
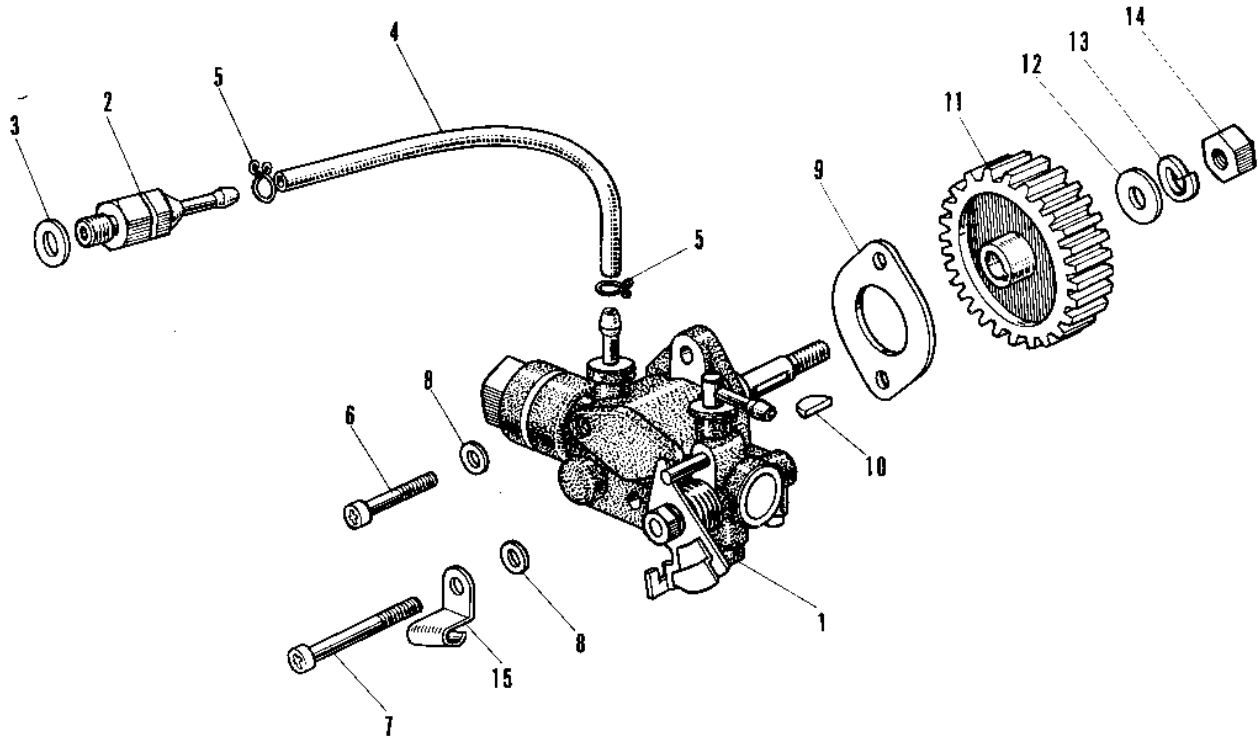

1969 Roadrunner PARTS LIST

OIL PUMP

ITEM NAME	PART NUMBER	QUANTITY
OIL PUMP ASSY (Ref # 1)	16082-005	1
CHECK VALVE (Ref # 2)	16087-001	1
GASKET 8MM (Ref # 3)	751P0800	1
PIPE OIL (Ref # 4)	16129-002	1
CLAMP OIL PUMP (Ref # 5)	92037-015	2
SCREW-PAN-CROS (Ref # 6)	220B0514	1
SCREW-PAN-CROS (Ref # 6)	220B0514	1
SCREW PAN CROSS,5X28 (Ref # 7)	220B0528	1
SCREW PAN CROSS,5X28 (Ref # 7)	220B0528	1
WASHER OIL PUMP (Ref # 8)	92022-037	2
GASKET,OIL PUMP (Ref # 9)	11060-1160	1
WOODRUFF KEY (Ref # 10)	510A2500	1
GEAR OIL PUMP (Ref # 11)	16085-001	1
WASHER PLAIN 6MM (Ref # 12)	410B0600	1
WASHER SPRING 6MM (Ref # 13)	461F0600	1
NUT 6MM (Ref # 14)	311B0600	1
GUIDE OVERFLOW PIPE (Ref # 15)	16068-001	1
"O" RING,HOUSING (Ref # 16)	16088-001	1
"O" RING,WORM GEAR (Ref # 17)	16090-001	1
SEAL-OIL,CAMSHAFT,"X" (Ref # 18)	92049-1294	1
SPRING OIL PUMP LEVER (Ref # 19)	16093-003	1