

1969 Roadrunner PARTS DIAGRAM

TRANSMISSION/CHANGE DRUM

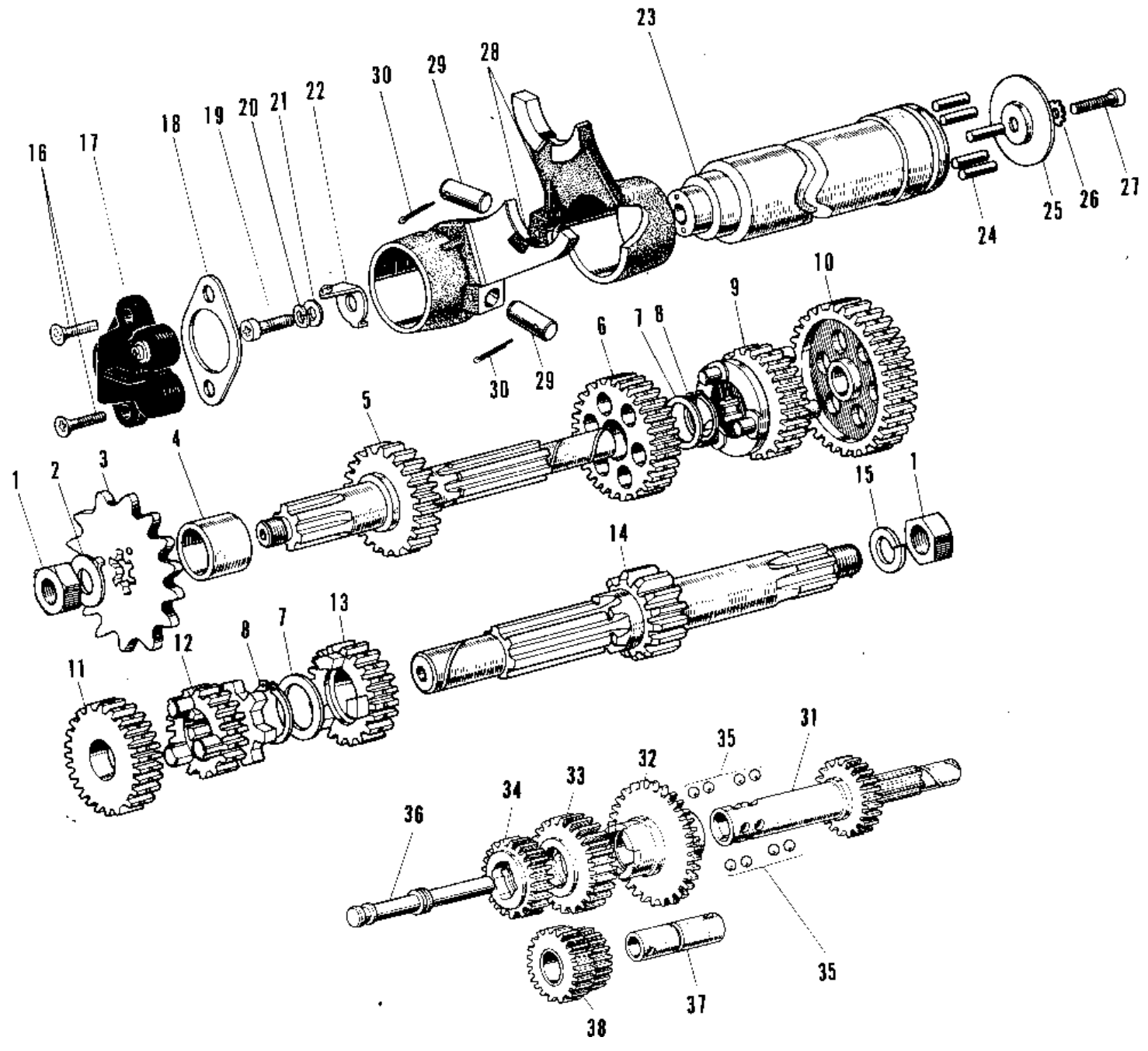

1969 Roadrunner PARTS LIST

TRANSMISSION/CHANGE DRUM

ITEM NAME	PART NUMBER	QUANTITY
NUT 12MM (Ref # 1)	92015-006	2
WASHER LOCK 12MM (Ref # 2)	92024-002	1
ENG SPROCKET ASSY 15 (Ref # 3)	13249-004	1
COLLAR DISTANCE (Ref # 4)	92027-019	1
SHAFT OUTPUT (Ref # 5)	13128-008	1
2ND GEAR OUTPUT SHAFT (Ref # 6)	13131-007	1
WASHER 18MM (Ref # 7)	92022-036	2
CIRCLIP 17MM (Ref # 8)	480J1700	2
3RD GEAR OUTPUT SHAFT (Ref # 9)	13133-004	1
LOW GEAR OUTPUT SHAFT (Ref # 10)	13129-009	1
TOP GEAR DRIVE SHAFT (Ref # 11)	13136-011	1
2ND GEAR DRIVE SHAFT (Ref # 12)	13130-006	1
3RD GEAR DRIVE SHAFT (Ref # 13)	13132-005	1
SHAFT DRIVE (Ref # 14)	13127-007	1
WASHER SPRING 12MM (Ref # 15)	461F1200	1
SCREW PAN HEAD 5X16 (Ref # 16)	220B0516	2
SCREW PAN HEAD 5X16 (Ref # 16)	220B0516A	2
SWITCH,NEUTRAL (Ref # 17)	13151-1001	1
GASKET NEUTRAL SWITCH (Ref # 18)	13146-002	1
UNAVAILABLE IN PRICE BOOK (Ref # 19)	92011-003	1
WASHER SPRING 6MM (Ref # 20)	461F0600	1
WASHER PLAIN 6MM (Ref # 21)	410B0600	1
ROTOR,NEUTRAL INDICTR (Ref # 22)	21007-1003	1
DRUM GEAR CHANGE (Ref # 23)	13141-021	1
PIN GEAR CHANGE DRUM (Ref # 24)	92043-004	5
PLATE CHANGE DRUM PIN (Ref # 25)	13142-003	1
WASHER LOCK 6MM (Ref # 26)	464H0600	1
SCREW PAN HEAD 6X12 (Ref # 27)	220B0612	1
FORK SELECTOR (Ref # 28)	13140-008	2

1969 Roadrunner PARTS LIST

TRANSMISSION/CHANGE DRUM

ITEM NAME	PART NUMBER	QUANTITY
PIN SELECT FORK GUIDE (Ref # 29)	92043-005	2
PIN COTTER 3.0X20 (Ref # 30)	550D3020	2