

1969 Roadrunner PARTS DIAGRAM

CRANKSHAFT/PISTON/ROTARY VALVE

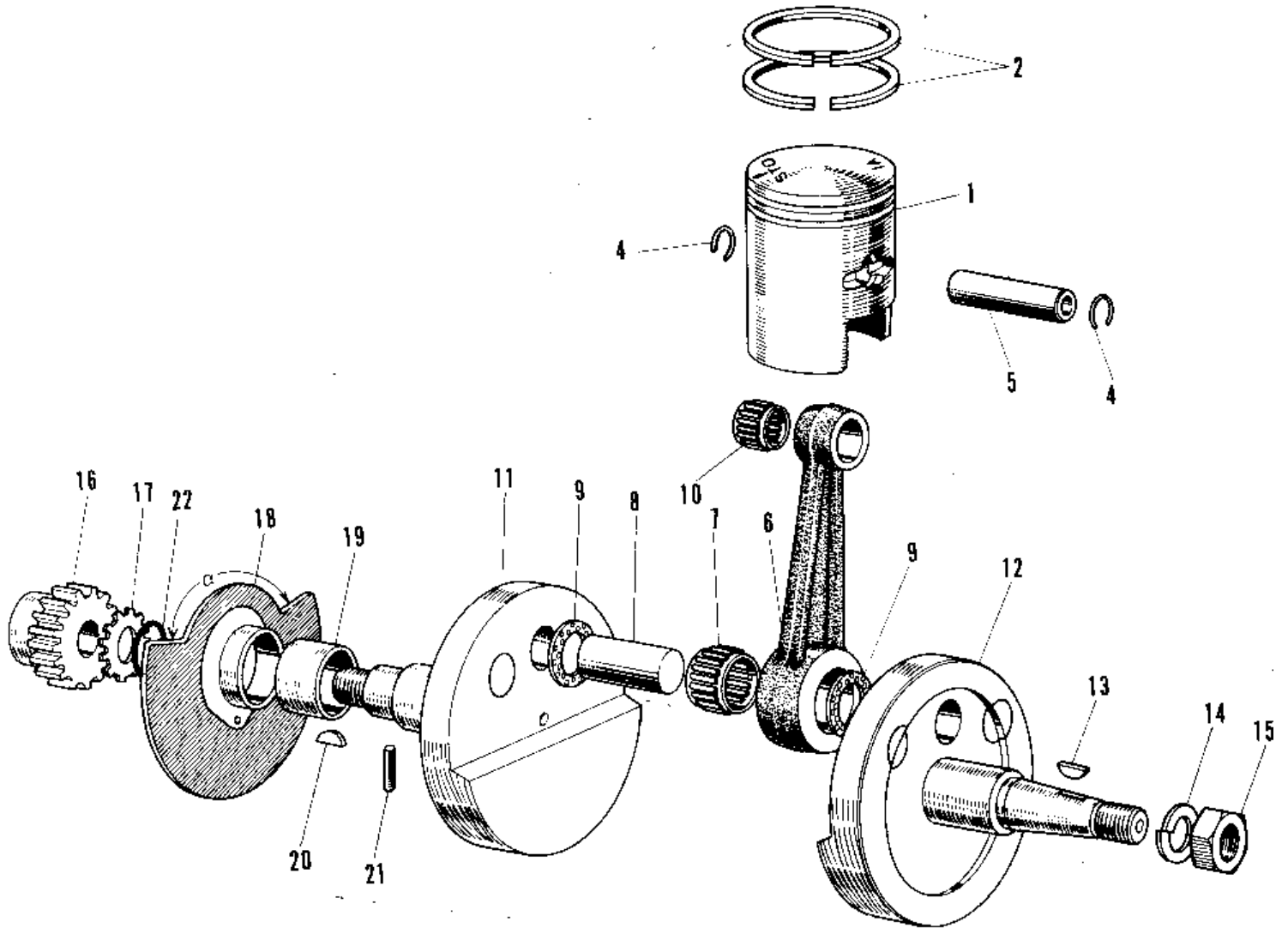

1969 Roadrunner PARTS LIST

CRANKSHAFT/PISTON/ROTARY VALVE

ITEM NAME	PART NUMBER	QUANTITY
PISTON STD (Ref # 1)	13001-013	1
RING SET STD (Ref # 2)	13008-002	1
CIRCLIP PISTON PIN (Ref # 4)	92036-005	1
PIN-PISTON (Ref # 5)	13002-002	1
CRANK - CONROD ASSY (Ref # 6 ~ 12)	13036-010	1
CONNECTING ROD SET (Ref # 6 ~ 9)	13044-003	1
NEEDLE BEARING BG END (Ref # 7)	13034-006	1
CRANK PIN (Ref # 8)	13035-006	1
WASHER SIDE (Ref # 9)	92026-011	1
NEEDLE BEARING SM END (Ref # 10)	13033-007	1
CRANKSHAFT R.H (Ref # 11)	13038-010	1
CRANKSHAFT L.H (Ref # 12)	13037-016	1
WOODRUFF KEY (Ref # 13)	92038-004	1
WASHER SPRING 10MM (Ref # 14)	461F1000	1
NUT,10MM (Ref # 15)	314B1000	1
PINION OIL PUMP (Ref # 16)	16084-001	1
WASHER LOCK 12MM (Ref # 17)	464G1200	1
ROTARY VALVE (Ref # 18)	12001-001	1
VALVE ROTARY DISC (Ref # 18)	12002-002	1
COLLAR CRANKSHAFT (Ref # 19)	92027-014	1
WOODRUFF KEY PRY PINI (Ref # 20)	92038-003	1
PIN DOWEL 4X10 (Ref # 21)	610A0410	1
"O" RING,16MM (Ref # 22)	670B2016	1