

1969 Mach III PARTS DIAGRAM

FRAME/FRAME FITTINGS ('69-'72 H1/A/B/C)

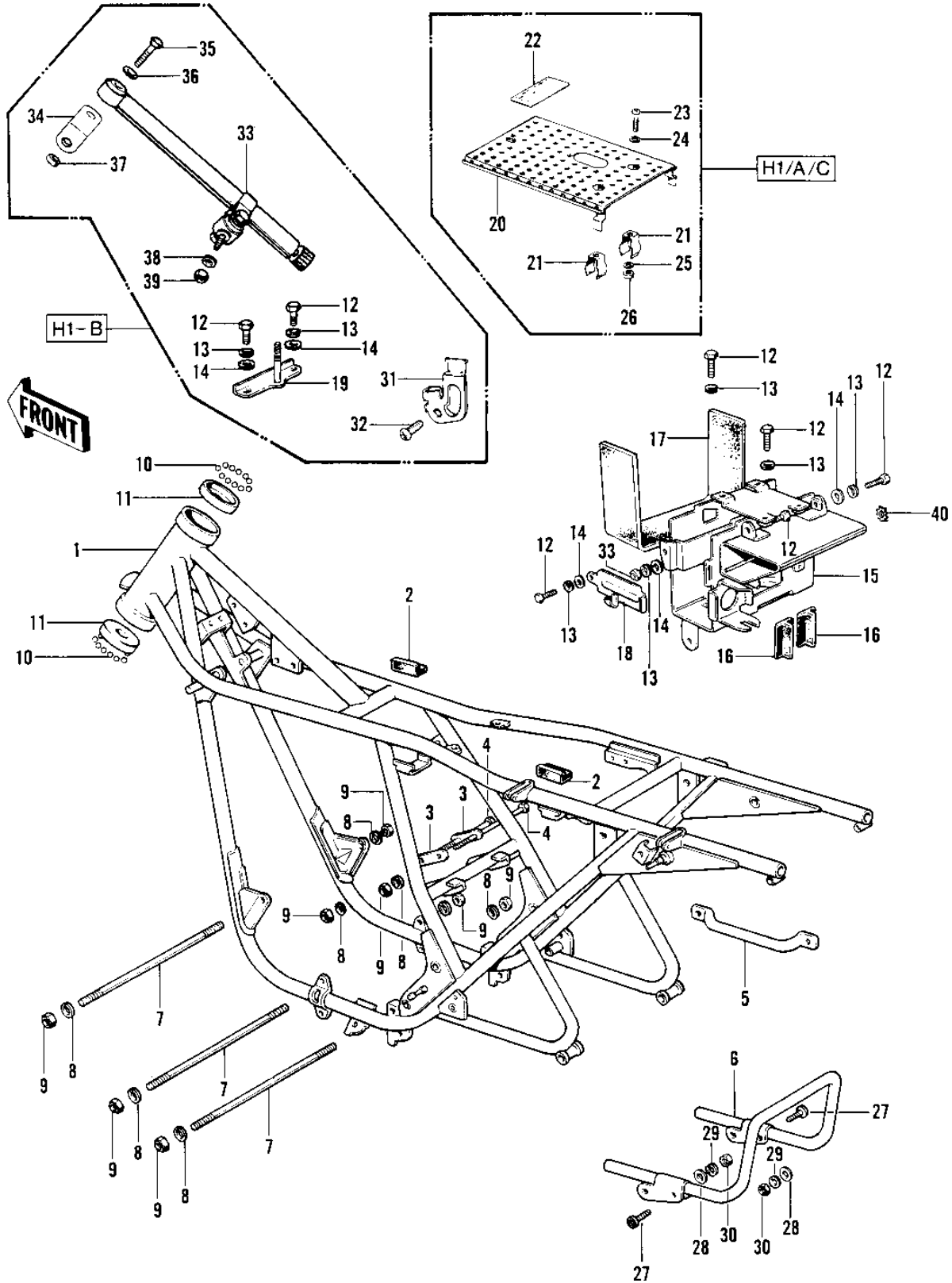

1969 Mach III PARTS LIST

FRAME/FRAME FITTINGS ('69-'72 H1/A/B/C)

ITEM NAME	PART NUMBER	QUANTITY
FRAME (Ref # 1)	32002-021	1
FRAME (Ref # 1)	32002-052	1
FRAME (Ref # 1)	32002-049	1
PROTECTOR SIDE COVER (Ref # 2)	31082-005	2
PLATE REAR ENG HOLDER (Ref # 3)	32030-016	2
BOLT,HEX HEAD,10X125 (Ref # 4)	92001-1248	2
GRIP FRAME (Ref # 5)	32109-009	1
STAY-REAR FENDER (Ref # 6)	35032-021	1
BOLT-ENG MOUNT,10X274 (Ref # 7)	92091-024	3
WASHER SPRING 10MM (Ref # 8)	461F1000	10
NUT,10MM (Ref # 9)	314B1000	10
BALL STEEL 1/4' (Ref # 10)	600A0800	38
RACE STRNG STEM BERNG (Ref # 11)	92048-006	2
BOLT-UPSET,6X16 (Ref # 12)	112G0616	5
BOLT-UPSET,6X16 (Ref # 12)	112G0616	7
WASHER SPRING 6MM (Ref # 13)	461F0600	5
WASHER SPRING 6MM (Ref # 13)	461F0600	7
WASHER PLAIN 6MM (Ref # 14)	411B0600	3
WASHER PLAIN 6MM (Ref # 14)	411B0600	5
BOX BATTERY - TOOL (Ref # 15)	32099-004	1
CASE-BATTERY&TOOL (Ref # 15)	32099-009	1
SEAT RECTIFIER RUBBER (Ref # 16)	32103-003	2
MAT BATTERY (Ref # 17)	32103-012	1
BAND BATTERY (Ref # 18)	32100-013	1
BRACKET-FUEL TANK (Ref # 19)	32051-005	1
PLATE-PUNCHED (Ref # 20)	32104-003	1
BRACKET (Ref # 21)	32095-003	2
LABLE (Ref # 22)	56020-010	2
SCREW PAN HEAD 6X10 (Ref # 23)	220B0610	2

1969 Mach III PARTS LIST

FRAME/FRAME FITTINGS ('69-'72 H1/A/B/C)

ITEM NAME	PART NUMBER	QUANTITY
WASHER PLAIN 6MM (Ref # 24)	411B0600	2
WASHER SPRING 6MM (Ref # 25)	461F0600	2
NUT 6MM (Ref # 26)	311B0600	2
REFLECTOR-REFLEX,REAR (Ref # 27)	28012-007	2
WASHER PLAIN 5MM (Ref # 28)	411B0500	2
WASHER SPRING 5MM (Ref # 29)	461F0500	2
NUT,5MM (Ref # 30)	311B0500	2
BRACKET-TURN SIG RELY (Ref # 31)	32064-008	1
BOLT-UPSET 6X14 (Ref # 32)	112B0614	1
OIL DAMPER-STEERING (Ref # 33)	46117-006	1
BRACKET-STEERING DAMP (Ref # 34)	32056-012	1
BOLT,FLANGED,8X60 (Ref # 35)	92001-1581	1
WASHER PLAIN 8MM (Ref # 36)	411B0800	1
NUT,LOCK,8MM (Ref # 37)	92015-1124	1
WASHER SPRING 8MM (Ref # 38)	461F0800	1
NUT,8MM (Ref # 39)	311B0800	1
WASHER LOCK 6MM (Ref # 40)	464H0600	2