

1998 1100 STX PARTS DIAGRAM

Cylinder Head/Cylinder

E1110

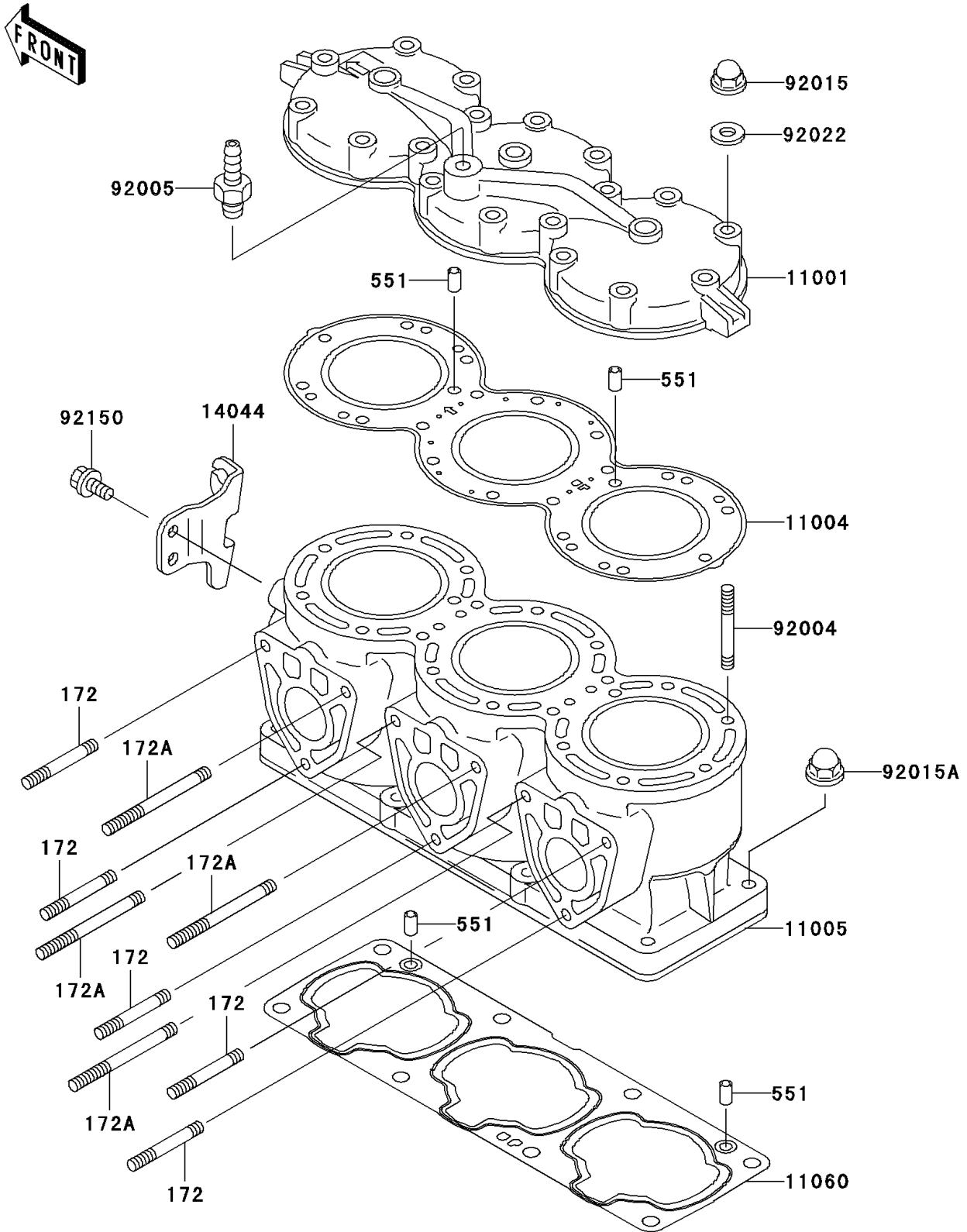

1998 1100 STX PARTS LIST

Cylinder Head/Cylinder

ITEM NAME	PART NUMBER	QUANTITY
BOLT-STUD (Ref # 172)	172R0830	1
BOLT-STUD,8X75 (Ref # 172A)	172R0875	1
PIN-DOWEL (Ref # 551)	551R0812	1
HEAD-CYLINDER (Ref # 11001)	11001-3723	1
GASKET-HEAD (Ref # 11004)	11004-3715	1
CYLINDER-ENGINE (Ref # 11005)	11005-3737	1
GASKET,CYLINDER BASE (Ref # 11060)	11060-3760	1
HOLDER-CABLE (Ref # 14044)	14044-3729	1
STUD,8X43 (Ref # 92004)	92004-3715	1
FITTING (Ref # 92005)	92005-3714	1
NUT,CAP,8MM (Ref # 92015)	92015-1371	1
NUT,10MM (Ref # 92015A)	92015-1649	1
WASHER,8.2X18X1.5 (Ref # 92022)	92022-1964	1
BOLT,8X16 (Ref # 92150)	92150-3722	1