

1980 KZ1300-A2 PARTS DIAGRAM

CLUTCH

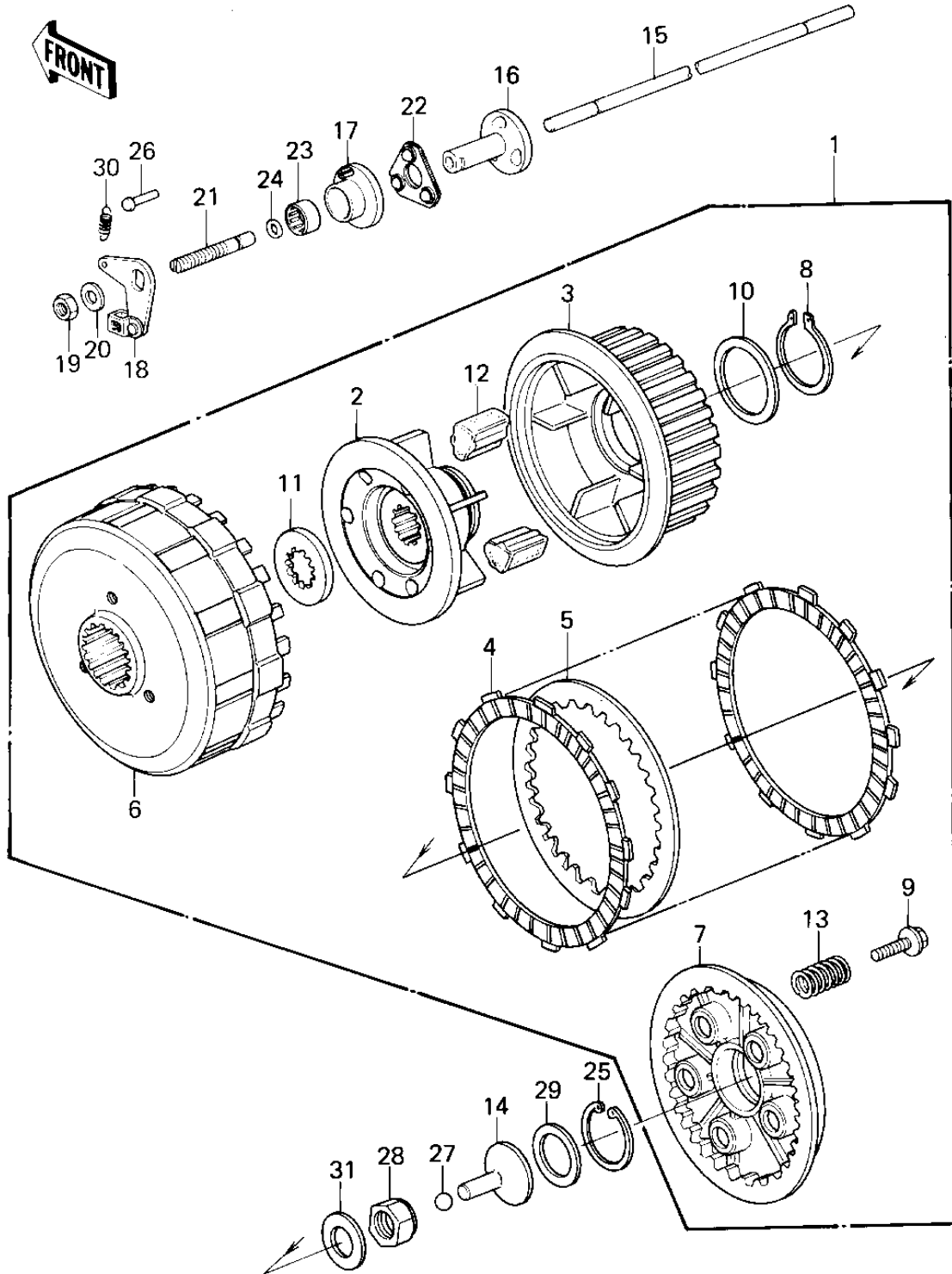

1980 KZ1300-A2 PARTS LIST

CLUTCH

ITEM NAME	PART NUMBER	QUANTITY
CLUTCH-ASSY (Ref # 1)	13081-1018	1
HUB,CLUTCH,INNER (Ref # 2)	13087-1006	1
HUB,CLUTCH,OUTER (Ref # 3)	13087-1007	1
PLATE,FRICITION (Ref # 4)	13088-1004	1
PLATE,CLUTCH,STEEL (Ref # 5)	13089-1003	1
HOUSING,CLUTCH (Ref # 6)	13096-1007	1
PLATE,CLUTCH SPRING (Ref # 7)	13187-1002	1
CIRCLIP,50MM (Ref # 8)	480J5000	1
BOLT,CLUTCH SPR FITT (Ref # 9)	92001-1066	1
WASHER,50.3X60X1.0 (Ref # 10)	92022-1081	1
WASHER,SPLINED (Ref # 11)	92022-1082	1
DAMPER,CLUTCH (Ref # 12)	92075-1088	1
SPRING,CLUTCH (Ref # 13)	92081-1149	1
PUSHER,CLUTCH SPRG PL (Ref # 14)	13116-022	1
ROD,PUSH,CLUTCH,8X328 (Ref # 15)	13116-1013	1
CAM,RELEASE,INNER (Ref # 16)	13119-1005	1
CAM,RELEASE,OUTER (Ref # 17)	13119-1006	1
LEVER,CLUTCH RELEASE (Ref # 18)	13236-1008	1
NUT 8MM (Ref # 19)	318B0800	1
WASHER PLAIN 8MM (Ref # 20)	411B0800	1
SCREW,SLOTTED,8M/M (Ref # 21)	92009-1038	1
BALL ASSY,CLUTCH RELE (Ref # 22)	92045-1014	1
BEARING,N,TLA1412 (Ref # 23)	92046-1013	1
"O" RING,5MM (Ref # 24)	670B1505	1
CIRCLIP,45MM (Ref # 25)	481J4500	1
RIVET,ROUND,4X20 (Ref # 26)	530C0420	1
BALL STEEL 3/8' (Ref # 27)	600A1200	1
NUT,20M/M,CLUTCH HUB (Ref # 28)	92015-1054	1
WASHER,30X44.7X3.2 (Ref # 29)	92022-1097	1

1980 KZ1300-A2 PARTS LIST

CLUTCH

ITEM NAME	PART NUMBER	QUANTITY
SPRING GEAR CHNG LEV (Ref # 30)	92083-011	1
WASHER (Ref # 31)	92125-002	1