

# 1978 KZ650-B2 PARTS DIAGRAM

## FOOTRESTS

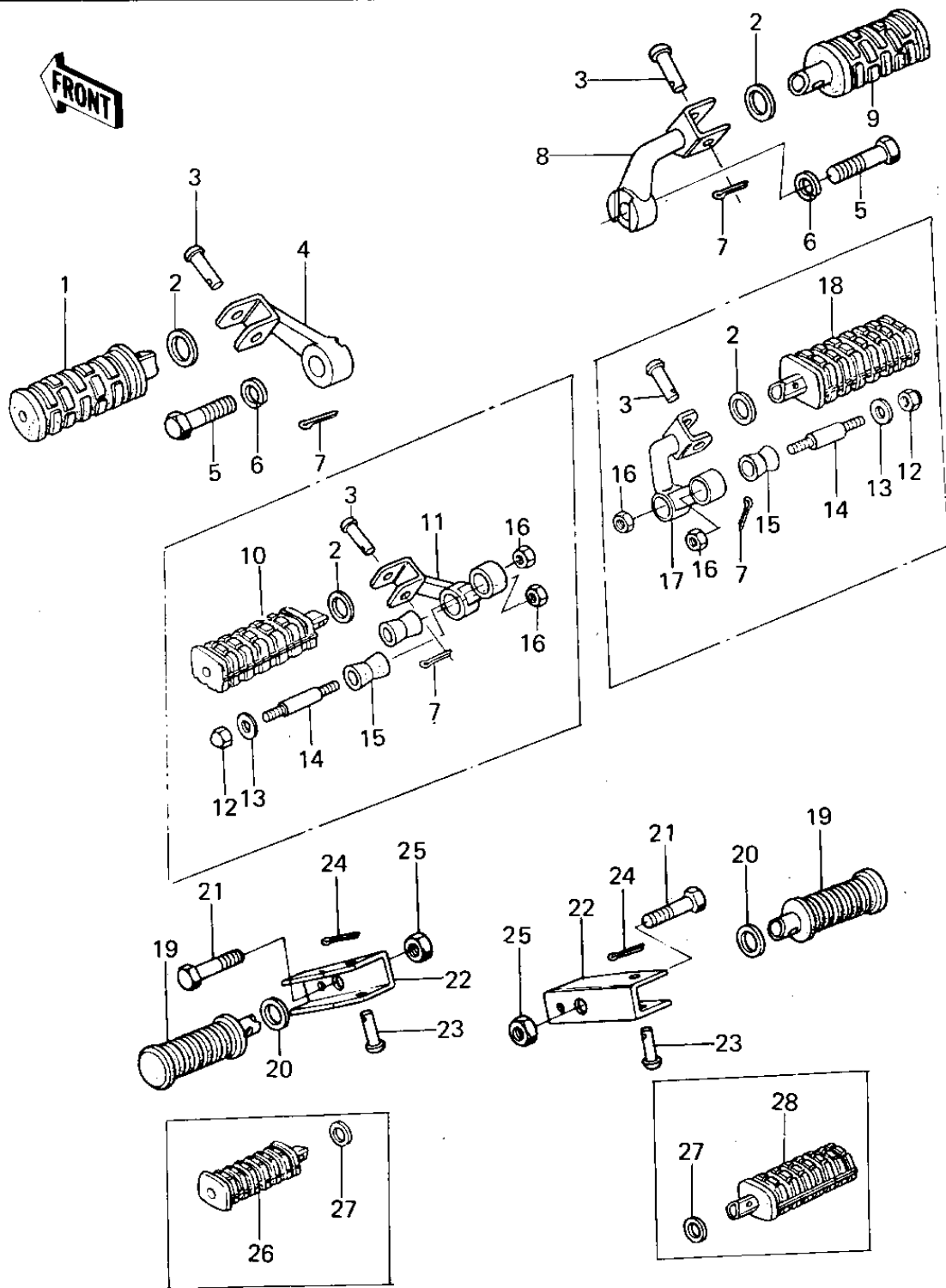

# 1978 KZ650-B2 PARTS LIST

## FOOTRESTS

ITEM NAME	PART NUMBER	QUANTITY
BAR-FOOTREST,L.H (Ref # 1)	34028-011	1
WASHER,PLAIN (Ref # 2)	92022-250	1
PIN-FOOTREST BAR FIT (Ref # 3)	92043-080	1
BRACKET FTR.BAR,L.H. (Ref # 4)	34003-063	1
BOLT HEX HEAD 12X40 (Ref # 5)	113G1240	1
WASHER SPRING 12MM (Ref # 6)	461F1200	1
PIN COTTER 2.5X16 (Ref # 7)	550D2516	1
BRACKET,FTR BAR,R.H. (Ref # 8)	34003-064	1
BAR-FOOTREST,R.H (Ref # 9)	34028-012	1
STEP,FOOTREST,FRONT,L (Ref # 10)	34028-1007	1
HOLDER,STEP,L.H. (Ref # 11)	34003-1012	1
NUT,CAP AND LOCK,8MM (Ref # 12)	92019-013	1
CAP,FOOTRESTBAR (Ref # 13)	92102-010	1
STUD,FOOTREST BAR FIT (Ref # 14)	92004-048	1
DAMPER RUBBER,FOOTRES (Ref # 15)	92075-293	1
NUT 10MM (Ref # 16)	315B1000	1
HOLDER,STEP,R.H. (Ref # 17)	34003-1015	1
STEP,FOOTREST,FRONT,R (Ref # 18)	34028-1008	1
RUBBER,FOOTREST (Ref # 19)	92076-027	1
WASHER-PLAIN (OPT) (Ref # 20)	92022-199	1
BOLT,HEX HEAD,10X40 (Ref # 21)	92003-213	1
BRACKET,REAR FOOTREST (Ref # 22)	34036-002	1
PIN (Ref # 23)	92043-1464	1
PIN,COTTER,2.0X12 (Ref # 24)	550D2012	1
NUT,LOCK,10MM (Ref # 25)	92019-021	1
STEP,FOOTREST,REAR,LH (Ref # 26)	34028-1009	1
WASHER-PLAIN (Ref # 27)	92022-181	1
STEP,FOOTREST,REAR,RH (Ref # 28)	34028-1010	1